

PRO **DECOR**

Inspired by Life

Griffkollektion

Handle Collection

Collection de poignées

Greepcollectie

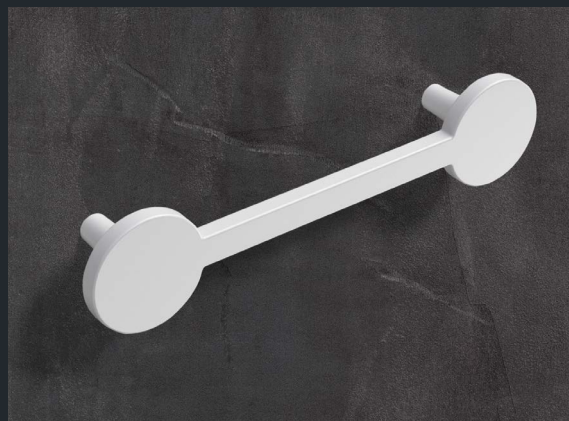

Technik für Möbel

Hettich

ProDecor – Inspired by Life

Übersicht | Summary | Vue d'ensemble | Overzicht

Zeichenerklärung

Key

Légende

Verklaring van de tekens

 Länge oder Breite
Length or width
Longueur ou largeur
Lengte of breedte

 Höhe
Height
Hauteur
Hoogte

 Bohrabstand
Hole distance
Distance d'écartement
Boorafstand

 Verpackungseinheit
Packaging unit
Unité d'emballage
Verpakkingseenheid

 Zum Ablängen
Cut to size
À recouper
Om op maat te maken

Alle Maße sind in mm angegeben
All measurements in mm
Toutes les mesures sont indiquées en mm
Alle afmetingen zijn in mm aangegeven

Alle Gewinde sind metrisch
All threads are metric
Tous les pas de vis sont métriques
Alle schroefdraden zijn metrisch

Wir empfehlen zum Festziehen des Griffes keine elektrisch betriebenen Werkzeuge zu verwenden.
We do not recommend using power tools to tighten the handle screws.

Nous vous recommandons de ne pas utiliser des outils électriques pour serrer la poignée à fond.

Voor het vastdraaien van de greep adviseren wij geen elektrisch werkend gereedschap te gebruiken.

Alle Naturmaterialien können in Farbe und Struktur von den Abbildungen abweichen.
All natural materials may vary in colour and structure from those depicted.

Tous les matériaux en matière naturelle peuvent être légèrement différents en finition ou en couleur par rapport à la photographie.
De kleur en de structuur van het natuurlijke materiaal kunnen afwijken van de afbeeldingen.

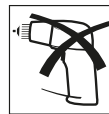

Reinigungsmittel für Griffe und Knöpfe:

- ▶ Weiches, fusselfreies Tuch und wasserlösliche milde Reinigungsmittel wie Flüssig- oder Neutralseife verwenden.
- ▶ Keine Scheuermittel/-schwämme, Nitro-Verdünnungen oder reizende/ätzende Chemikalien verwenden, diese können die Oberflächen langfristig schädigen!
- ▶ Generell sollten Flecken so schnell wie möglich entfernt werden, um ein Einziehen in die Oberflächen zu vermeiden.

Cleaning products for handles and knobs:

- ▶ Please use a soft, lint free cloth and mild water-soluble detergents such as liquid or neutral soap.
- ▶ Do not use any abrasive cleaners, scouring pads, cellulose thinners or irritant/corrosive chemicals as these may damage the surface over time!
- ▶ Marks should always be removed as quickly as possible to prevent them from staining the surface.

Détergent pour poignées et boutons :

- ▶ Utiliser un chiffon doux et non pelucheux avec un détergent doux et soluble dans l'eau tel que du savon liquide ou neutre.
- ▶ Ne pas utiliser de détergents abrasifs, ni d'éponges à récurer, ni de diluants pour laque cellulosique, ni de produits chimiques irritants/corrosifs qui risquent d'endommager à long terme les surfaces !
- ▶ D'une manière générale, il faut effacer le plus vite possible les taches pour éviter qu'elles ne s'incruster dans les surfaces.

Reinigingsmiddelen voor grepen en knoppen:

- ▶ Gebruik een zachte, niet pluizende doek en in water oplosbare, milde schoonmaakmiddelen als vloeibare zeep of groene zeep.
- ▶ Gebruik geen schuurspoonsjes/schurende schoonmaakmiddelen, nitroverduunners of bijtende/irriterende chemicaliën, hierdoor zouden de oppervlakken op termijn beschadigd raken!
- ▶ Vlekken moeten altijd zo snel mogelijk worden verwijderd, zodat deze niet in het oppervlak kunnen dringen.



Stilwelt NEW MODERN | NEW MODERN style world | L'univers de style NEW MODERN |
Stijlrichting NEW MODERN

Übersicht | Summary | Vue d'ensemble | Overzicht 4 - 5
Griffe und Knöpfe | Handles and knobs | Poignées et boutons | Grepen en knoppen 6 - 39



Stilwelt DELUXE | DELUXE style world | L'univers de style DELUXE | Stijlrichting DELUXE

Übersicht | Summary | Vue d'ensemble | Overzicht 40
Griffe und Knöpfe | Handles and knobs | Poignées et boutons | Grepen en knoppen 42 - 54



Stilwelt ORGANIC | ORGANIC style world | L'univers de style ORGANIC | Stijlrichting ORGANIC

Übersicht | Summary | Vue d'ensemble | Overzicht 56 - 57
Griffe und Knöpfe | Handles and knobs | Poignées et boutons | Grepen en knoppen 58 - 79



Stilwelt FOLK | FOLK style world | L'univers de style FOLK | Stijlrichting FOLK

Übersicht | Summary | Vue d'ensemble | Overzicht 80 - 81
Griffe und Knöpfe | Handles and knobs | Poignées et boutons | Grepen en knoppen 82 - 103



Touch-in 104

Griffe | Handles | Poignées | Grepen 105 - 109



Zubehör, Arbeitshilfen | Accessories, work assistants | Accessoires et aides pour la réalisation |
Toebehoren, verwerkingshulpmiddelen 110 - 121
Übersicht nach Materialien | Summary by materials | Vue d'ensemble en fonction des matériaux |
Overzichtelijk gesorteerd op materiaal 122 - 126
Sachwortverzeichnis | Index | Liste des termes clés | Trefwoordenregister 127
Bestellnummern | Order numbers | Références | Bestelnummers 128 - 131

Raumgestaltung ist der Ausdruck persönlichen Stils. Deshalb gibt es die vier ProDecor Stilwelten: für Wohnen mit Persönlichkeit.

Interior design is an expression of personal style. This is why there are four ProDecor style worlds: for homes with personality.

NEW MODERN



DELUXE

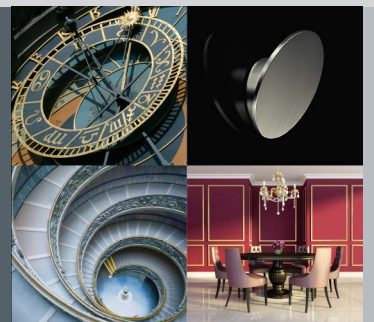

Technik. Transparenz. Sachlichkeit.

NEW MODERN beeindruckt durch seine klare, futuristische Formensprache und coole Haptik. Die meisterhafte Vollendung puristischer Möbelfronten.

Technology. Transparency. Practicality.

NEW MODERN impresses with its clear cut, futuristic style and cool touch. Purist looking furniture fronts in masterful perfection.

Technologie. Transparence. Sobriété.

NEW MODERN impressionne par ses formes claires et futuristes ainsi que par sa finition au toucher sympathique. C'est l'accomplissement magistral des façades de meubles aux lignes épurées.

Techniek. Transparentie. Zakelijkheid.

NEW MODERN maakt indruk door zijn heldere, futuristische vormtaal en coole, voelbare eigenschappen. De meesterlijke volmaaktheid van puristische fronten.

Sinnlich wohnen – mit einem Hauch Luxus:

Schillernde Metalle und majestätische Farben prägen die Stilwelt DELUXE. Das kraftvolle Griffdesign zaubert sinnliche Atmosphäre in den Raum und verführt zur Berührung ...

Homes that speak to the senses – with a touch of luxury:

Shimmering metals and majestic colours define the DELUXE style world. The powerful handle design conjures an ambience that pleases the senses, extending an irresistible invitation to touch ...

L'habitat qui éveille tous les sens – avec un souffle de luxe :

les métaux scintillants et les couleurs majestueuses marquent l'univers du style DELUXE. Le design puissant des poignées crée une atmosphère dans la pièce qui éveille tous les sens et donne envie de toucher ...

Wonen met gevoel – en een vleugje luxe:

Stijlwereld DELUXE wordt gekenmerkt door glinsterende metalen en majestueuze kleuren. Het krachtige greepdesign zorgt voor een zinnelijke sfeer in de ruimte en vraagt erom aangeraakt te worden...

L'aménagement intérieur reflète le style de chacun. C'est pourquoi il existe quatre univers de style ProDecor : pour habiter dans un environnement personnalisé

Een interieur is de expressie van een persoonlijke stijl. Daarom heeft ProDecor vier stijlrichtingen: voor wonen met persoonlijkheid.

ORGANIC



FOLK



Die Idylle der unberührten Natur.

Diese Kollektion lebt von organischen Formen und naturnahen, rauen Oberflächen. Wohnen mit natürlichem Charme? Willkommen in der ORGANIC Stilwelt!

The idyll of unspoiled nature.

This collection is fired by organic shapes and natural looking, rough feeling finishes. Want to live with nature's charm? Welcome to the world of ORGANIC style!

L'idylle de la nature intacte.

Cette collection vit des formes organiques et des surfaces rugueuses écologiques. Peut-on habiter dans un cadre au charme naturel ? Oui, c'est possible. Bienvenue dans l'univers du style ORGANIC !

De idylle van de ongerepte natuur.

Deze collectie floreert door organische vormen en natuurgetrouwe, ruwe oppervlakken. Wonen met natuurlijke charme? Welkom in de wereld van ORGANIC!

Möbelgriffe, die Geschichten erzählen.

Traditionelle Formen und Farben. Üppige Muster und weiche Oberflächen, die man gerne berührt. Raffinierte Used-Optik strahlt sympathische Wärme aus. FOLK ist pure Freude. Auch für Ihre Kunden.

Furniture handles that tell stories.

Traditional shapes and colours. Opulent patterns and soft finishes you want to touch. Ingeniously crafted used looks exude appealing warmth. FOLK is pure joy. For your customers too.

Des poignées de meubles qui racontent des histoires.

Des formes et des couleurs traditionnelles. Des motifs exubérants et des surfaces douces que l'on touche volontiers. L'aspect usagé raffiné donne à chaque pièce une ambiance chaleureuse sympathique. FOLK, c'est le bonheur à l'état pur. Également pour vos clients.

Meubelgrepen die een verhaal vertellen.

Traditionele vormen en kleuren. Weelderige motieven en zachte oppervlakken die graag worden aangeraakt. Een geraffineerde used look straalt sympathieke warmte uit. FOLK is pure vreugde, ook voor uw klanten.

NEW MODERN



6 Tempe



6 Vigilia



7 Apua



7 Nubia



8 Torino



8 Velitra



9 Capua



9 Imperia



9 Evisa



10 Zenga



11 Bermeo

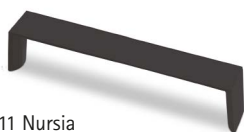

11 Nursia



12 Cheam



12 Tornea



13 Anzio



13 Arnun



14 Aratti



14 Aosta



15 Clivia



16 Alvito



16 Pola



16 Guarani



16 Narona



17 Hale



18 Salvia



19 Kervo



19 Fermo



20 Stabia



21 Rovigo



22/23 Canis L



24/25 Canis C



26 Celista



26 Genoa



27 Rialto



27 Messina



28 Milo



28 Venusia



29 Trani



29 Ticinum



30 Narni



30 Empoli



35 Genzone



38 Agrinum



31 Lamezia



35 Capris



38 Monacum



32 Lindavia



36 Nidum



39 Danum



32 Lutetia



36 Spira



39 Sion



32 Eslinga



37 Misnia



39 Spalatum



32 Seveso



37 Apolda



33 Mosena



38 Novae

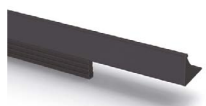

34 Riaza



38 Onex

NEW MODERN

Tempe



Edelstahl gebürstet
Brushed stainless steel
Inox brossé
Roestvrij staal geborsteld

	☐
9 191 722	10

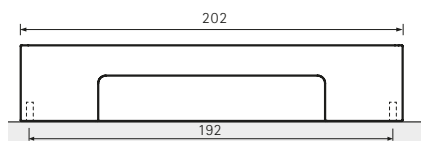

Vigilia



1 Verchromt glanz
Bright chrome plated
Chromé brillant
Verchromd glans



2 Edelstahl Optik gebürstet
Brushed stainless steel look
Aspect inox brossé
Roestvrij staal finish geborsteld

		☐
1	9 065 627	25
2	9 065 628	25

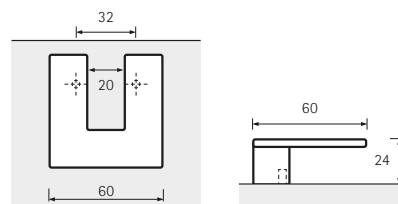

Apua



Edelstahl Optik gebürstet
Brushed stainless steel look
Aspect inox brossé
Roestvrij staal finish geborsteld

Nubia



1 Verchromt glanz
Bright chrome plated
Chromé brillant
Verchromd glans



2 Edelstahl Optik gebürstet
Brushed stainless steel look
Aspect inox brossé
Roestvrij staal finish geborsteld

•••	•	□
160	172	9 112 672 40
224 / 260	272	9 112 674 40
320 / 360	372	9 064 819 25
416 / 460	472	9 064 820 25

	•••	•	□
1	192	245	9 106 166 30
1	256	309	9 106 167 50
1	256	373	9 106 168 25
1	192 / 352	437	9 106 169 25
2	192	245	9 105 837 30
2	256	309	9 105 838 50
2	256	373	9 105 839 25
2	192 / 352	437	9 105 840 25

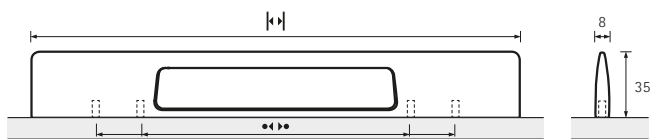
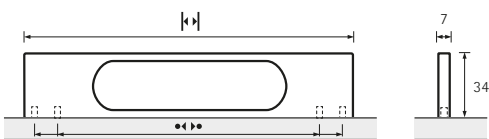

NEW MODERN

Torino



- 1 Verchromt glanz
Bright chrome plated
Chromé brillant
Verchromd glans



- 2 Edelfstahl Optik gebürstet
Brushed stainless steel look
Aspect inox brossé
Roestvrij staal finish geborsteld

Velitra



- 1 Verchromt glanz
Bright chrome plated
Chromé brillant
Verchromd glans



- 2 Edelfstahl Optik gebürstet
Brushed stainless steel look
Aspect inox brossé
Roestvrij staal finish geborsteld

	•••	•	□
1	160 / 192	232	9 071 927 50
1	224 / 256	296	9 071 930 50
2	160 / 192	232	9 071 926 50
2	224 / 256	296	9 071 929 50

	•••	•	□
1	128 / 192	204	9 208 551 50
1	224 / 260	272	9 208 578 50
1	260 / 320	372	9 208 579 25
1	360 / 416	472	9 208 580 25
2	128 / 192	204	0 115 018 50
2	224 / 260	272	0 115 014 50
2	260 / 320	372	0 115 016 25
2	360 / 416	472	0 115 017 25

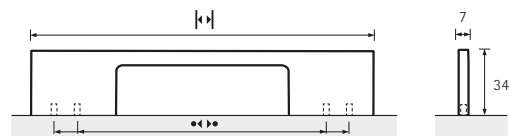
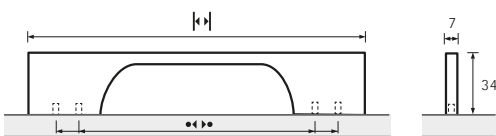

Capua



Edelstahl Optik gebürstet
Brushed stainless steel look
Aspect inox brossé
Roestvrij staal finish geborsteld

•••	•		□
160	172	9 112 666	40
224 / 260	272	9 112 667	40
320 / 360	372	9 064 670	25
416 / 460	472	9 064 671	25

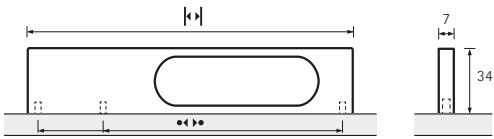

Imperia



Edelstahl Optik gebürstet
Brushed stainless steel look
Aspect inox brossé
Roestvrij staal finish geborsteld

•••	•		□
192	220	9 995 585	40
224	252	9 995 586	40
320	348	9 995 587	40
448	476	9 995 588	40
541	569	9 995 589	40
560	588	9 995 590	40

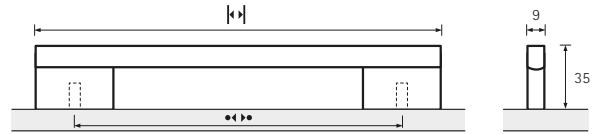

Evisa



1 Verchromt glanz
Bright chrome plated
Chromé brillant
Verchromd glans



2 Edelstahl Optik gebürstet
Brushed stainless steel look
Aspect inox brossé
Roestvrij staal finish geborsteld

		□
1	9 113 501	30
2	9 113 502	30

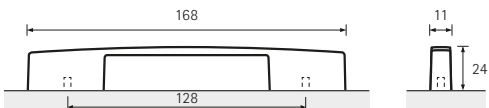

NEW MODERN

Zenga



1 Verchromt glanz
Bright chrome plated
Chromé brillant
Verchromd glans



3 Verchromt glanz
Bright chrome plated
Chromé brillant
Verchromd glans



2 Edeldahl Optik gebürstet
Brushed stainless steel look
Aspect inox brossé
Roestvrij staal finish geborsteld



4 Edeldahl Optik gebürstet
Brushed stainless steel look
Aspect inox brossé
Roestvrij staal finish geborsteld

		□
1	9 105 742	25
2	9 105 743	25

		□
3	9 105 746	25
4	9 105 747	25

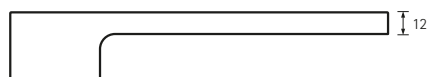
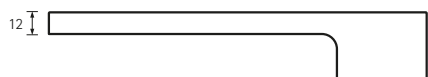
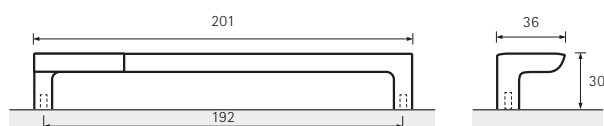
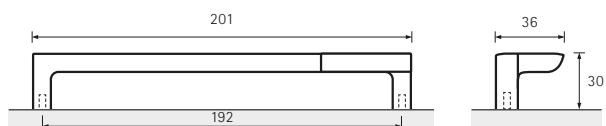

Bermeo



- 1 Edelstahl Optik gebürstet
Brushed stainless steel look
Aspect inox brossé
Roestvrij staal finish geborsteld



- 2 Schwarz matt /
Edelstahl Optik gebürstet
Matt black /
Brushed stainless steel look
Noir mat /
Aspect inox brossé
Zwart mat /
Roestvrij staal finish geborsteld

Nursia



- 1 Verchromt matt
Matt chrome plated
Chromé mat
Verchromd mat



- 2 Edelstahl Optik gebürstet
Brushed stainless steel look
Aspect inox brossé
Roestvrij staal finish geborsteld

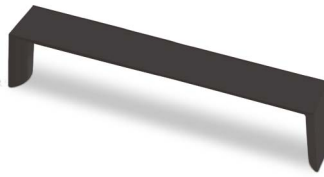

- 3 Schwarz matt
Matt black
Noir mat
Zwart mat

	•••			□
1	96	109	9 208 073	30
1	128	141	9 208 074	25
1	160	173	9 208 075	25
1	192	205	9 208 076	25
1	224	237	9 208 077	25
1	256	269	9 208 078	50
1	288	301	9 208 079	50
1	320	333	9 208 080	50
2	96	109	9 208 081	30
2	128	141	9 208 082	25
2	160	173	9 208 083	25
2	192	205	9 208 084	25
2	224	237	9 208 085	25
2	256	269	9 208 086	50
2	288	301	9 208 087	50
2	320	333	9 208 088	50

		□
1	9 120 199	25
2	9 112 637	25
3	9 264 087	25

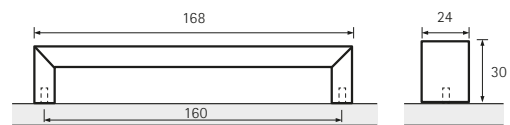
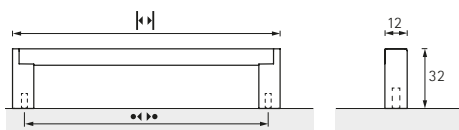

NEW MODERN

Cheam



- 1 Edelstahl Optik gebürstet
Brushed stainless steel look
Aspect inox brossé
Roestvrij staal finish geborsteld



- 2 Schwarz matt
Matt black
Noir mat
Zwart mat

Tornea



- 1 Verchromt glanz
Bright chrome plated
Chromé brillant
Verchromd glans



- 2 Edelstahl Optik gebürstet
Brushed stainless steel look
Aspect inox brossé
Roestvrij staal finish geborsteld



- 3 Schwarz matt
Matt black
Noir mat
Zwart mat

	•••	•		□
1	128	163	9 268 262	20
1	160	195	9 268 219	25
1	192	227	9 113 212	20
2	128	163	9 252 428	20
2	160	195	9 252 429	25
2	192	227	9 252 430	20

	•••	•		□
1	128	138	9 112 938	50
1	192	202	9 112 941	50
2	128	138	9 112 940	50
2	192	202	9 112 943	50
3	128	138	9 269 731	50
3	192	202	9 269 732	50

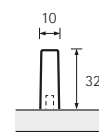
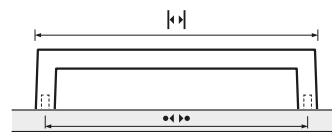
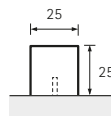

Anzio

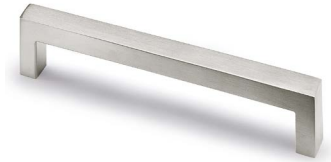

Edelstahl gebürstet
Brushed stainless steel
Inox brossé
Roestvrij staal geborsteld

Arnum



Edelstahl gebürstet
Brushed stainless steel
Inox brossé
Roestvrij staal geborsteld

•••	k ₁	k ₂	□
96	106	10	9 204 164 35
128	138	10	1 160 018 30
160	170	10	1 160 019 30
192	202	10	9 204 175 40
224	234	10	1 160 020 50
288	298	10	1 160 021 50
320	330	10	9 204 177 50
352	362	10	1 160 022 50
480	490	10	1 160 023 50
608	618	10	1 160 024 50
736	746	10	1 160 025 50

•••	k ₁	k ₂	□
160	172	12	9 207 348 40
192	204	12	9 207 356 40
320	332	12	9 207 349 50
416	428	12	9 207 350 40
512	524	12	9 207 351 40
736	748	12	9 207 352 40
832	844	12	9 207 354 40

k	□
10	9 208 071 150
12	9 208 072 150

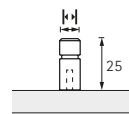
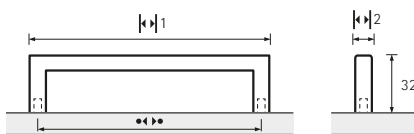

NEW MODERN

Aratti



Edelstahl gebürstet
Brushed stainless steel
Inox brossé
Roestvrij staal geborsteld

Aosta



Edelstahl gebürstet
Brushed stainless steel
Inox brossé
Roestvrij staal geborsteld

•••	•		□
96	112	9 113 247	30
128	144	9 069 804	50
160	176	9 069 805	25
192	208	9 069 806	25
224	240	9 069 807	25
256	272	9 113 248	40
320	336	9 069 808	25
352	368	9 113 250	25
384	400	9 113 251	25
416	432	9 113 252	25
480	496	9 207 357	25
584	600	9 113 255	25
684	700	9 113 257	25
784	800	9 113 258	25
984	1000	9 207 358	25

□
9 208 070 150

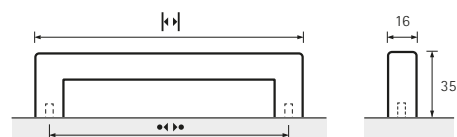
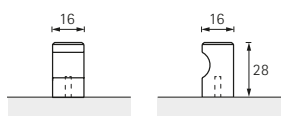

Clivia



1 Aluminium eloxiert
Aluminium, anodised
Aluminium anodisé
Aluminium geëloxeerd



2 Schwarz matt
Matt black
Noir mat
Zwart mat

	•••	•		□
1	96	108	0 115 205	50
1	128	140	0 115 355	50
1	160	172	0 115 353	50
1	192	204	0 115 354	50
1	208	220	0 115 215	25
1	224	236	0 115 206	25
1	232	244	0 115 356	50
1	256	268	0 115 207	25
1	282	294	0 115 357	25
1	288	300	0 115 208	25
1	332	344	0 115 358	25
1	352	364	0 115 209	20
1	382	394	0 115 359	25

	•••	•		□
1	416	428	0 115 210	20
1	432	444	0 115 360	25
1	448	460	0 115 211	25
1	482	494	0 115 361	25
1	512	524	0 115 213	25
1	532	544	0 115 362	25
1	544	556	0 115 214	25
1	632	644	0 115 364	25
1	732	744	0 115 363	25
1	2 x 416	844	0 115 212	25
1	2 x 477,5	967	0 115 216	25
1	2 x 564	1140	0 115 217	20
1	2 x 644	1300	0 115 218	20

	•••	•		□
2	96	108	9 265 888	50
2	128	140	9 265 879	50
2	160	172	9 265 880	50
2	192	204	9 265 921	50
2	208	220	9 265 922	25
2	224	236	9 265 923	25
2	232	244	9 265 924	50
2	256	268	9 265 925	25
2	282	294	9 265 926	25
2	288	300	9 265 927	25
2	332	344	9 265 928	25
2	352	364	9 265 929	20
2	382	394	9 265 930	25

	•••	•		□
2	416	428	9 265 931	20
2	432	444	9 265 932	25
2	448	460	9 265 933	25
2	482	494	9 265 934	25
2	512	524	9 265 935	25
2	532	544	9 265 936	25
2	544	556	9 265 937	25
2	632	644	9 265 938	25
2	732	744	9 265 939	25
2	2 x 416	844	9 265 940	25
2	2 x 477,5	967	9 265 941	25
2	2 x 564	1140	9 265 942	20
2	2 x 644	1300	9 265 943	20

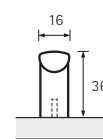
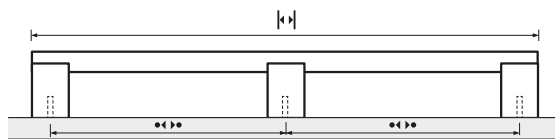

NEW MODERN

Alvito



Verchromt glanz
Bright chrome plated
Chromé brillant
Verchromd glans



•••	•	□
9 113 635	150	

Pola



Edelstahl gebürstet
Brushed stainless steel
Inox brossé
Roestvrij staal geborsteld

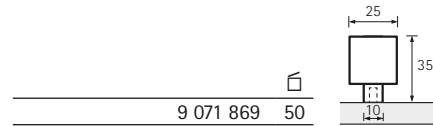

•••	•	□
9 071 869	50	

Guarani



Edelstahl gebürstet
Brushed stainless steel
Inox brossé
Roestvrij staal geborsteld

•••	•	□
128	149	9 208 046 40
160	181	9 208 047 50
192	223	9 208 048 50
224	259	9 208 049 50

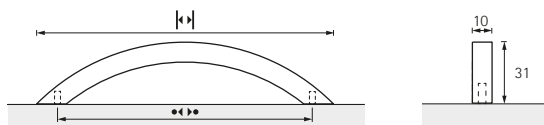

Narona



Edelstahl gebürstet
Brushed stainless steel
Inox brossé
Roestvrij staal geborsteld

•••	•	□
96	108	9 070 970 50
128	140	9 070 973 25
160	172	9 070 975 40
192	204	9 070 992 40
224	236	9 203 963 40
288	300	9 070 995 50
320	332	9 070 998 50
352	364	9 070 977 25
384	396	9 070 979 25

•••	•	□
480	492	9 071 000 25
640	652	9 071 010 15
736	748	9 071 013 15

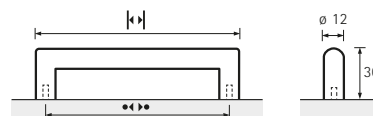

Hale



- 1 Verchromt glanz
Bright chrome plated
Chromé brillant
Verchromd glans

	•••	•		□
1	96	156	9 070 807	20
1	128	188	9 070 809	40
1	160	220	9 070 811	40
1	192	252	9 070 817	40
1	224	284	9 070 821	50
1	288	348	9 070 813	25
1	352	412	9 070 825	25
1	448	508	9 070 803	25
1	480	540	9 070 816	25



- 2 Edelhstahl Optik gebürstet
Brushed stainless steel look
Aspect inox brossé
Roestvrij staal finish geborsteld

	•••	•		□
2	96	156	9 070 674	20
2	128	188	9 070 750	40
2	160	220	9 070 796	40
2	184	244	9 070 746	40
2	192	252	9 070 765	40
2	224	284	9 070 763	50
2	234	294	9 070 742	50
2	284	344	9 070 734	50
2	288	348	9 070 759	25
2	334	394	9 070 733	25
2	352	412	9 070 758	25
2	384	444	9 070 732	25
2	434	494	9 070 736	25
2	448	508	9 070 756	25
2	480	540	9 070 753	25
2	484	544	9 070 738	25
2	784	844	9 070 743	20
2	2 x 453,5	967	9 070 747	15
2	2 x 540	1140	9 070 751	15
2	2 x 620	1300	9 070 755	15

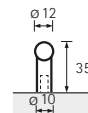
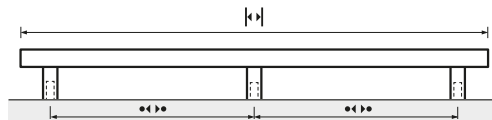
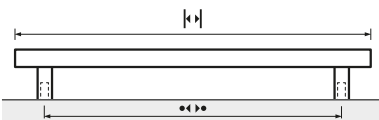

NEW MODERN

Salvia



Edelstahl gebürstet
Brushed stainless steel
Inox brossé
Roestvrij staal geborsteld

∅ 10



∅	•••			□
10	96	156	9 070 967	50
10	128	188	9 070 972	50
10	160	220	9 070 978	50
10	192	252	9 070 982	50
10	224	284	9 070 984	75
10	256	316	9 070 988	75
10	288	348	9 070 991	25
10	320	380	9 070 993	20
10	352	412	9 070 996	20
10	384	444	9 070 999	20

∅ 14



∅	•••			□
14	96	158	9 071 045	50
14	128	188	9 071 046	25
14	160	220	9 071 048	25
14	192	252	9 071 050	25
14	224	284	9 071 051	25
14	256	316	9 071 052	25
14	288	348	9 071 053	25
14	320	380	9 071 054	20
14	352	412	9 071 055	20
14	384	444	9 071 056	20
14	448	508	9 071 058	20
14	480	540	9 071 111	20
14	640	700	9 071 112	15
14	736	796	9 071 115	15
14	2 x 480	1020	9 071 116	15
14	2 x 640	1340	9 071 118	1
14	2 x 720	1500	9 071 120	1

∅ 12



∅	•••			□
12	96	157	9 071 003	50
12	128	188	9 071 005	50
12	160	220	9 071 008	50
12	192	252	9 071 009	50
12	224	284	9 071 012	50
12	256	316	9 071 017	50
12	288	348	9 071 020	25
12	320	380	9 071 021	20
12	352	412	9 071 023	20
12	384	444	9 071 024	20
12	448	508	9 071 026	20
12	480	540	9 071 027	20
12	640	700	9 071 030	15
12	736	796	9 071 038	15
12	2 x 480	1020	9 071 041	15
12	2 x 640	1340	9 071 042	1
12	2 x 720	1500	9 071 043	1

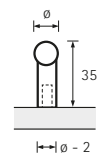
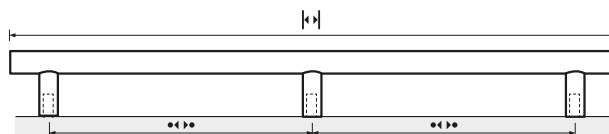

Kervo



- 1 Aluminium eloxiert
Aluminium, anodised
Aluminium anodisé
Aluminium geëloxeerd



- 2 Schwarz matt
Matt black
Noir mat
Zwart mat

Fermo



- 1 Verchromt glanz
Bright chrome plated
Chromé brillant
Verchromd glans



- 2 Edeldstahl Optik gebürstet
Brushed stainless steel look
Aspect inox brossé
Roestvrij staal finish geborsteld

	•••	•		□
1	32	56	9 190 436	100
1	64	88	9 194 367	100
1	96 / 128	152	9 190 437	100
1	160 / 192	216	9 190 438	50
1	224 / 256	280	9 190 439	100
1	5 x 224	1100	9 190 440	25
2	32	56	9 190 441	100
2	64	88	9 194 368	100
2	96 / 128	152	9 190 442	100
2	160 / 192	216	9 190 443	50
2	224 / 256	280	9 190 444	100

		□
1	0 115 020	50
2	0 115 019	50

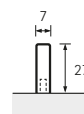
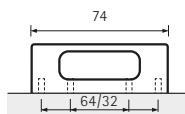
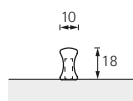
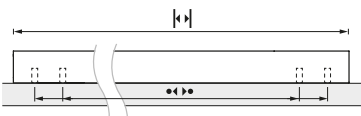

NEW MODERN

Stabia



- 1 Verchromt glanz
Bright chrome plated
Chromé brillant
Verchromd glans



- 3 Edalstahl Optik gebürstet
Brushed stainless steel look
Aspect inox brossé
Roestvrij staal finish geborsteld



- 2 Aluminium eloxiert
Aluminium, anodised
Aluminium anodisé
Aluminium geëloxeerd

	•••	•	□		•••	•	□		
1	64	76	9 209 059	100	3	64	76	9 204 159	100
1	96	108	9 209 060	100	3	96	108	9 204 161	100
1	128	140	9 209 061	50	3	128	140	9 204 162	50
1	160	172	9 209 062	75	3	160	172	9 204 163	75
1	192	204	9 209 063	75	3	192	204	9 204 160	75
1	224	236	9 209 064	50	3	224	236	9 209 058	50
2	64	76	9 204 157	100					
2	96	108	0 115 023	100					
2	128	140	0 115 021	50					
2	160	172	0 115 022	75					
2	192	204	9 204 158	75					
2	224	236	0 115 024	50					
2	13 x 224	2924	9 120 134	8					

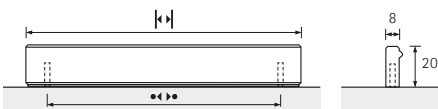

Rovigo



1 Verchromt glanz
Bright chrome plated
Chromé brillant
Verchroomd glans



3 Edeldahl Optik gebürstet
Brushed stainless steel look
Aspect inox brossé
Roestvrij staal finish geborsteld



2 Aluminium eloxiert
Aluminium, anodised
Aluminium anodisé
Aluminium geëloxeerd

	«»	«		□
1	64	79	9 204 195	40
1	96	111	9 204 022	35
1	128	143	9 204 023	25
1	160	175	9 113 297	25
1	192	207	9 204 024	25
1	224	239	9 113 299	25
2	64	79	9 204 197	40
2	96	111	9 204 028	35
2	128	143	9 204 029	25
2	160	175	9 204 030	25
2	192	207	9 204 031	25
2	224	239	9 204 032	25
2	8 x 224	2000	9 204 033	8

	«»	«		□
3	64	79	9 204 196	40
3	96	111	9 204 025	35
3	128	143	9 204 026	25
3	160	175	9 113 298	25
3	192	207	9 204 027	25
3	224	239	9 113 300	25

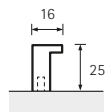

NEW MODERN

Canis L



1 Aluminium eloxiert
Aluminium, anodised
Aluminium anodisé
Aluminium geëloxeerd



2 Edelstahl Optik
Stainless steel look
Aspect inox
Roestvrij staal finish



3 Schwarz matt
Matt black
Noir mat
Zwart mat



4 Innenecke 90° / Aluminium Optik
90° inside corner / Aluminium look
Angle intérieur 90° / Aspect aluminium
Binnenhoek 90° / Aluminiumkleurig



5 Innenecke 90° / Edelstahl Optik
90° inside corner / Stainless steel look
Angle intérieur 90° / Aspect inox
Binnenhoek 90° / Roestvrij staal finish



6 Innenecke 90° / Schwarz matt
90° inside corner / Matt black
Angle intérieur 90° / Noir mat
Binnenhoek 90° / Zwart mat

		□	⊗
1	9 210 115	8	⊗
2	9 210 116	8	⊗
3	9 266 104	8	⊗

		□
4	9 210 117	50
5	9 210 119	50
6	9 266 105	50



7 Außenecke 90° / Aluminium Optik
90° outside corner / Aluminium look
Angle extérieur 90° / Aspect aluminium
Buitenhoek 90° / Aluminiumkleurig



8 Außenecke 90° / Edelstahl Optik
90° outside corner / Stainless steel look
Angle extérieur 90° / Aspect inox
Buitenhoek 90° / Roestvrij staal finish



9 Außenecke 90° / Schwarz matt
90° outside corner / Matt black
Angle extérieur 90° / Noir mat
Buitenhoek 90° / Zwart mat

7	9 210 122	50	
8	9 210 125	50	
9	9 266 106	50	



10 Endkappen geschlossen, Set / Aluminium Optik
Set of closed end caps / Aluminium look
Kit d'embouts fermés / Aspect aluminium
Set gesloten eindkappen / Aluminiumkleurig



11 Endkappen geschlossen, Set / Edelstahl Optik
Set of closed end caps / Stainless steel look
Kit d'embouts fermés / Aspect inox
Set gesloten eindkappen / Roestvrij staal finish



12 Endkappen geschlossen, Set / Schwarz matt
Set of closed end caps / Matt black
Kit d'embouts fermés / Noir mat
Set gesloten eindkappen / Zwart mat

10	9 210 126	50	
11	9 210 128	50	
12	9 266 107	50	



13 Befestigungswinkel / Stahl verzinkt
Fixing bracket / Galvanised steel
Cornières de fixation / Acier zingué
Bevestigingshoek / Verzinkt staal



14 Befestigungswinkel gekröpft, beim Einsatz von Endkappen / Stahl verzinkt
Fixing bracket cranked, required when using end caps / Galvanised steel
Cornières de fixation coudée, nécessaire en cas d'utilisation de embouts / Acier zingué
Bevestigingshoek bocht, bij gebruik van eindkappen / Verzinkt staal



15 Befestigungswinkel / Stahl verzinkt
Fixing bracket / Galvanised steel
Cornières de fixation / Acier zingué
Bevestigingshoek / Verzinkt staal

13	9 210 142	100	
14	9 210 143	100	
15	9 210 129	100	

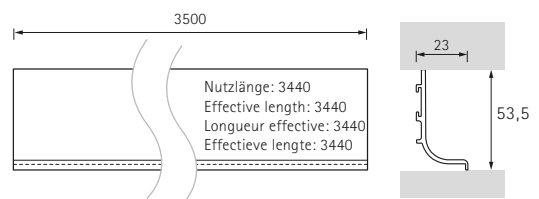

NEW MODERN

Canis C



1 Aluminium eloxiert
Aluminium, anodised
Aluminium anodisé
Aluminium geëloxeerd



2 Edelstahl Optik
Stainless steel look
Aspect inox
Roestvrij staal finish



3 Schwarz matt
Matt black
Noir mat
Zwart mat



4 Innenecke 90° / Aluminium Optik
90° inside corner / Aluminium look
Angle intérieur 90° / Aspect aluminium
Binnenhoek 90° / Aluminiumkleurig



5 Innenecke 90° / Edelstahl Optik
90° inside corner / Stainless steel look
Angle intérieur 90° / Aspect inox
Binnenhoek 90° / Roestvrij staal finish



6 Innenecke 90° / Schwarz matt
90° inside corner / Matt black
Angle intérieur 90° / Noir mat
Binnenhoek 90° / Zwart mat

		□	⊙
1	9 210 130	8	⊙
2	9 210 132	8	⊙
3	9 266 132	8	⊙

		□
4	9 210 133	50
5	9 210 136	50
6	9 266 133	50



7 Außenecke 90° / Aluminium Optik
90° outside corner / Aluminium look
Angle extérieur 90° / Aspect aluminium
Buitenhoek 90° / Aluminiumkleurig



8 Außenecke 90° / Edelstahl Optik
90° outside corner / Stainless steel look
Angle extérieur 90° / Aspect inox
Buitenhoek 90° / Roestvrij staal finish



9 Außenecke 90° / Schwarz matt
90° outside corner / Matt black
Angle extérieur 90° / Noir mat
Buitenhoek 90° / Zwart mat

			☐
7	9 210 138	50	
8	9 210 139	50	
9	9 266 134	50	



13 Befestigungswinkel / Stahl verzinkt
Fixing bracket / Galvanised steel
Cornières de fixation / Acier zingué
Bevestigingshoek / Verzinkt staal



14 Befestigungswinkel gekröpft, beim Einsatz von Endkappen / Stahl verzinkt
Fixing bracket cranked, required when using end caps / Galvanised steel
Cornières de fixation coudée, nécessaire en cas d'utilisation de embouts / Acier zingué
Bevestigingshoek bocht, bij gebruik van eindkappen / Verzinkt staal



15 Befestigungswinkel / Stahl verzinkt
Fixing bracket / Galvanised steel
Cornières de fixation / Acier zingué
Bevestigingshoek / Verzinkt staal

			☐
13	9 210 142	100	
14	9 210 143	100	
15	9 210 129	100	



10 Endkappen geschlossen, Set / Aluminium Optik
Set of closed end caps / Aluminium look
Kit d'embouts fermés / Aspect aluminium
Set gesloten eindkappen / Aluminiumkleurig



11 Endkappen geschlossen, Set / Edelstahl Optik
Set of closed end caps / Stainless steel look
Kit d'embouts fermés / Aspect inox
Set gesloten eindkappen / Roestvrij staal finish



12 Endkappen geschlossen, Set / Schwarz matt
Set of closed end caps / Matt black
Kit d'embouts fermés / Noir mat
Set gesloten eindkappen / Zwart mat

			☐
10	9 210 140	50	
11	9 210 141	50	
12	9 266 135	50	

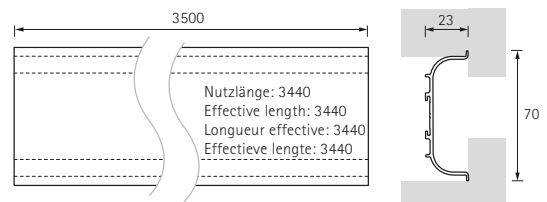

NEW MODERN

Celista



1 Weiß
White
Blanc
Wit



2 Edelstahl Optik gebürstet
Brushed stainless steel look
Aspect inox brossé
Roestvrij staal finish geborsteld



3 Schwarz matt
Matt black
Noir mat
Zwart mat

		☐
1	9 082 137	25
2	9 080 838	25
3	9 082 136	25



Genoa



1 Verchromt glanz
Bright chrome plated
Chromé brillant
Verchromd glans



2 Edelstahl Optik gebürstet
Brushed stainless steel look
Aspect inox brossé
Roestvrij staal finish geborsteld

		☐
1	9 065 611	30
2	9 065 612	30

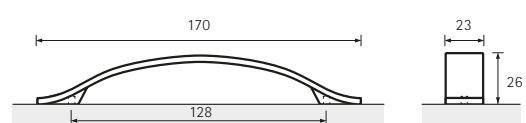

Rialto



1 Verchromt glanz
Bright chrome plated
Chromé brillant
Verchromd glans



2 Edelstahl Optik gebürstet
Brushed stainless steel look
Aspect inox brossé
Roestvrij staal finish geborsteld



3 Schwarz matt
Matt black
Noir mat
Zwart mat

Messana



1 Verchromt glanz
Bright chrome plated
Chromé brillant
Verchromd glans



2 Edelstahl Optik gebürstet
Brushed stainless steel look
Aspect inox brossé
Roestvrij staal finish geborsteld

			☐
1	9 097 953	25	
2	9 097 950	25	
3	9 264 086	25	

			☐
1	0 115 157	50	
2	0 115 156	50	

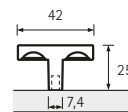
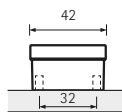
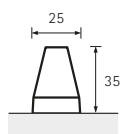
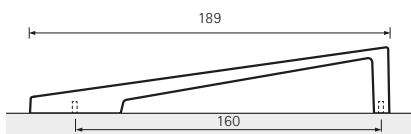

NEW MODERN

Milo



1 Verchromt glanz
Bright chrome plated
Chromé brillant
Verchroomd glans



2 Edeldahl Optik gebürstet
Brushed stainless steel look
Aspect inox brossé
Roestvrij staal finish geborsteld

1	9 105 793	100	
2	9 105 794	100	

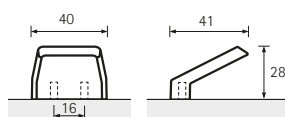

Venusia



1 Verchromt glanz
Bright chrome plated
Chromé brillant
Verchroomd glans



2 Edeldahl Optik gebürstet
Brushed stainless steel look
Aspect inox brossé
Roestvrij staal finish geborsteld

1	0 115 155	25	
2	0 115 154	25	

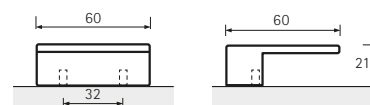

Trani



1 Aluminium eloxiert
Aluminium, anodised
Aluminium anodisé
Aluminium geëloxeerd



2 Schwarz matt
Matt black
Noir mat
Zwart mat

Ticinum



1 Aluminium eloxiert
Aluminium, anodised
Aluminium anodisé
Aluminium geëloxeerd

	•••	•		□
1	32	52	9 995 437	60
1	64	84	9 995 438	50
1	96	116	9 995 439	50
1	128	148	9 995 440	25
2	32	52	9 265 949	60
2	64	84	9 265 950	50
2	96	116	9 265 971	50
2	128	148	9 265 972	25

	•••	•		□
	32	50	9 070 583	75
	50	70	9 070 588	75
	70	90	9 070 593	50
	8 x 224	2000	9 131 455	12

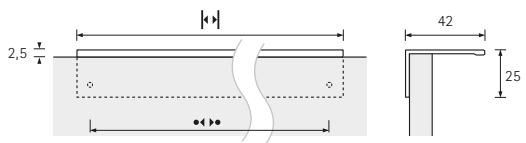
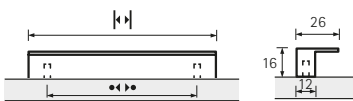

NEW MODERN

Narni



Edelstahl gebürstet
Brushed stainless steel
Inox brossé
Roestvrij staal geborsteld

Empoli



1 Verchromt glanz
Bright chrome plated
Chromé brillant
Verchromd glans



2 Verchromt matt
Matt chrome plated
Chromé mat
Verchromd mat



3 Edelstahl Optik gebürstet
Brushed stainless steel look
Aspect inox brossé
Roestvrij staal finish geborsteld

•••	••		□
20	30	9 995 574	75
50	60	9 158 400	50
80	90	9 206 741	50

		□
1	9 995 541	70
2	9 995 540	70
3	9 995 542	70

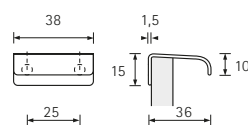
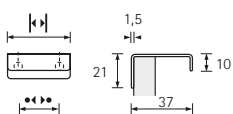

Lamezia



- 1 Verchromt glanz
Bright chrome plated
Chromé brillant
Verchromd glans



- 2 Aluminium eloxiert
Aluminium, anodised
Aluminium anodisé
Aluminium geëloxeerd



- 3 Edielstahl Optik gebürstet
Brushed stainless steel look
Aspect inox brossé
Roestvrij staal finish geborsteld



- 4 Schwarz matt
Matt black
Noir mat
Zwart mat



- 5 Gold Optik matt gebürstet
Gold look matt brushed
Aspect doré brossé mat
Goudkleurig mat geborsteld

		□
1	295	9 105 801 50
1	345	9 105 802 25
1	395	9 105 803 25
1	445	9 105 805 25
1	495	9 105 806 25
1	595	9 105 807 25
1	795	9 105 809 25
1	895	9 105 810 25
1	995	9 105 811 25
1	1195	9 105 813 20
2	295	9 105 827 50
2	345	9 105 828 25
2	395	9 105 829 25
2	445	9 105 830 25
2	495	9 105 831 25
2	595	9 105 832 25
2	795	9 105 833 25
2	895	9 105 834 25
2	995	9 105 835 25
2	1195	9 105 836 20
3	295	9 105 815 50
3	345	9 105 816 25
3	395	9 105 819 25
3	445	9 105 820 25
3	495	9 105 821 25
3	595	9 105 822 25
3	795	9 105 823 25
3	895	9 105 824 25
3	995	9 105 825 25
3	1195	9 105 826 20
4	295	9 265 973 50
4	345	9 265 975 25
4	395	9 265 976 25
4	445	9 265 977 25
4	495	9 265 978 25
4	595	9 265 979 25
4	795	9 265 980 25
4	895	9 265 981 25
4	995	9 265 982 25
4	1195	9 265 983 20
5	295	9 265 985 50
5	345	9 265 986 25
5	395	9 265 987 25
5	445	9 265 988 25
5	495	9 265 989 25
5	595	9 265 990 25
5	795	9 265 991 25
5	895	9 265 992 25
5	995	9 265 993 25
5	1195	9 265 994 20

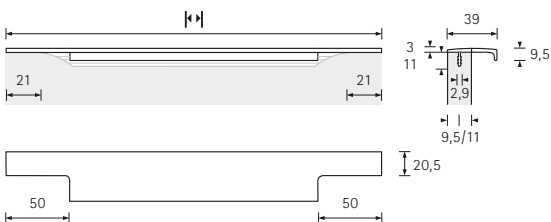

NEW MODERN

Lindavia



Aluminium eloxiert
Aluminium, anodised
Aluminium anodisé
Aluminium geëloxeerd

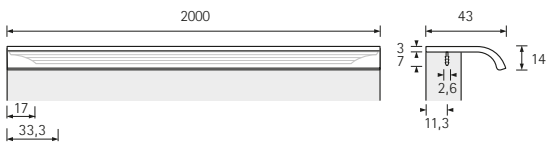
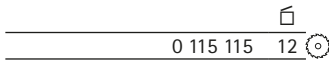

Lutetia



Aluminium eloxiert
Aluminium, anodised
Aluminium anodisé
Aluminium geëloxeerd

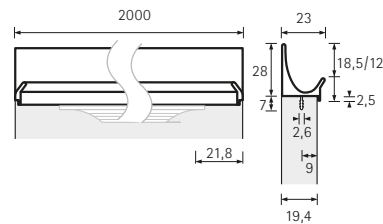
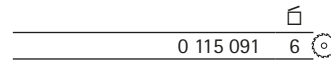

Eslinga



Aluminium eloxiert
Aluminium, anodised
Aluminium anodisé
Aluminium geëloxeerd

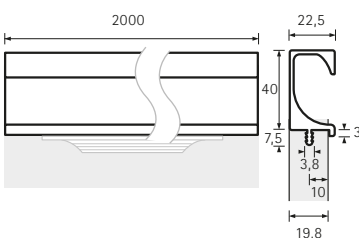
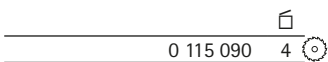

Seveso



Aluminium eloxiert
Aluminium, anodised
Aluminium anodisé
Aluminium geëloxeerd

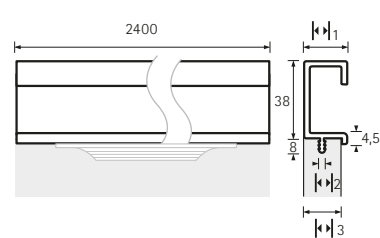

k ₁	k ₂	k ₃			
17	3	17	9 995 122	6	6
19	3	19	9 995 123	6	6



Mosena



Aluminium eloxiert
 Aluminium, anodised
 Aluminium anodisé
 Aluminium geëloxeerd

9 237 970 10  

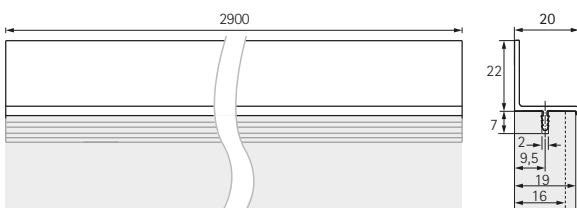

NEW MODERN

Riaza



- 1 Aluminium eloxiert
Aluminium, anodised
Aluminium anodisé
Aluminium geëloxeerd

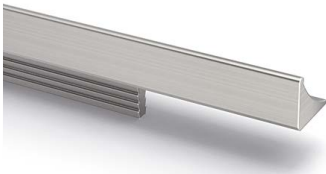

- 2 Edelstahl Optik gebürstet
Brushed stainless steel look
Aspect inox brossé
Roestvrij staal finish geborsteld

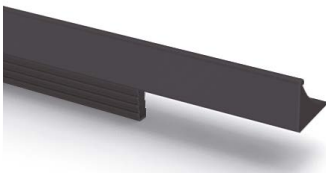

- 3 Schwarz matt
Matt black
Noir mat
Zwart mat

			□
1	295	9 208 097	30
1	395	9 208 098	20
1	445	9 208 099	20
1	495	9 208 100	20
1	595	9 208 101	20
1	795	9 208 102	20
1	895	9 208 103	20
1	2400	9 266 102	6 
2	295	9 208 089	30
2	395	9 208 090	20
2	445	9 208 091	20
2	495	9 208 092	20
2	595	9 208 093	20
2	795	9 208 094	20
2	895	9 208 095	20
3	295	9 266 095	30
3	395	9 266 096	20
3	445	9 266 097	20
3	495	9 266 098	20
3	595	9 266 099	20
3	795	9 266 100	20
3	895	9 266 101	20

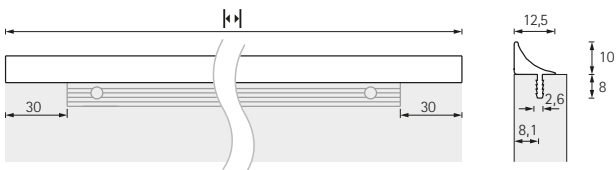

Genzone

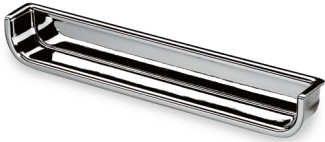

- 1 Verchromt glanz
Bright chrome plated
Chromé brillant
Verchromd glans



- 2 Edelstahl Optik gebürstet
Brushed stainless steel look
Aspect inox brossé
Roestvrij staal finish geborsteld

Capris

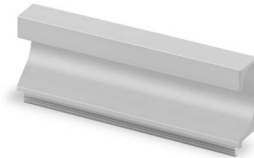

- 1 Aluminium eloxiert
Aluminium, anodised
Aluminium anodisé
Aluminium geëloxeerd



- 2 Edelstahl Optik
Stainless steel look
Aspect inox
Roestvrij staal finish



- 3 Endkappen-Set / Aluminium Optik
Set of end caps / Aluminium look
Kit d'embouts / Aspect aluminium
Eindkappen set / Aluminiumkleurig



- 4 Endkappen-Set / Vernickelt matt Optik
Set of end caps / Matt nickel plated look
Kit d'embouts / Aspect nickelé mat
Eindkappen set / Vernickeld mat

			☐
1	9 145 262	50	
2	9 145 263	50	

				☐
1	9 149 293	8	⊙	
2	9 149 296	8	⊙	
3	0 115 028	50		
4	0 115 049	50		

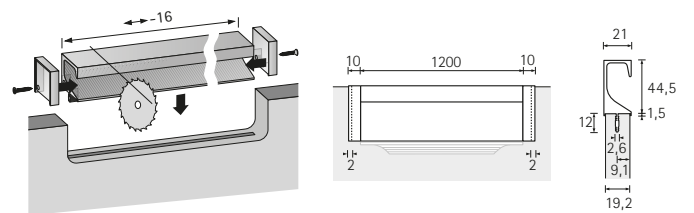
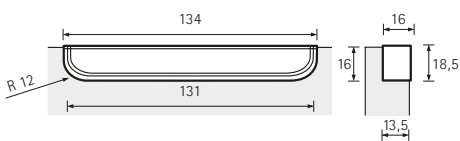

NEW MODERN

Nidum



Aluminium Optik
Aluminium look
Aspect aluminium
Aluminiumkleurig

Spira



1 Aluminium eloxiert
Aluminium, anodised
Aluminium anodisé
Aluminium geëloxeerd



2 Endkappen-Set / Aluminium Optik
Set of end caps / Aluminium look
Kit d'embouts / Aspect aluminium
Eindkappen set / Aluminiumkleurig

•••	₁	₂		□
96	111	107	9 071 060	25
128	143	139	9 071 071	25
160	175	171	9 071 073	25
192	207	203	9 071 075	25
256	271	267	9 071 079	50
320	335	331	9 071 082	50

		□	○
1	0 115 314	6	
2	0 115 298	100	

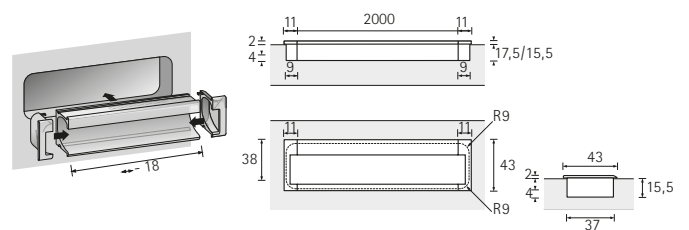
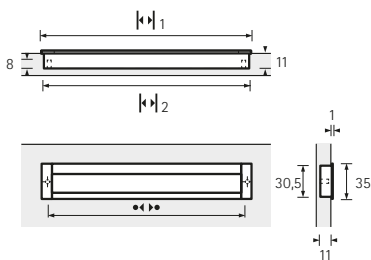

Misnia



1 Aluminium Optik
Aluminium look
Aspect aluminium
Aluminiumkleurig



2 Vernickelt matt Optik
Matt nickel plated look
Aspect nickelé mat
Vernikkeld mat

Apolda



1 Edelstahl gebürstet
Brushed stainless steel
Inox brossé
Roestvrij staal geborsteld



2 Edelstahl gebürstet / Schwarz glänzend
Brushed stainless steel / Polished black
Inox brossé / Noir brillant
Roestvrij staal geborsteld / Zwart glanzend

	•••	₁	₂		□
1	96	116	111	0 115 181	50
1	160	180	176	0 115 127	25
2	96	116	111	0 115 182	50
2	160	180	176	0 115 183	25

		□
1	9 191 745	20
2	9 207 531	20

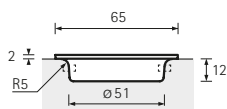
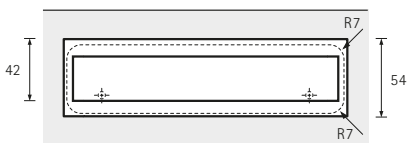
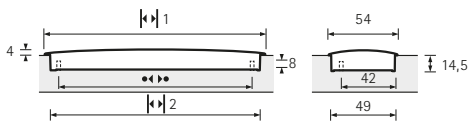

NEW MODERN

Novae



- 1 Verchromt glanz
Bright chrome plated
Chromé brillant
Verchromd glans
- 2 Vernickelt matt
Matt nickel plated
Nickelé mat
Vernikkeld mat

	Ø	H	Weight	Material
1	19	28	100	9 112 634
2	14,5	28	100	9 112 633

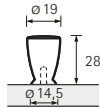

Onex



Edelstahl gebürstet
Brushed stainless steel
Inox brossé
Roestvrij staal geborsteld

	Ø	H	Weight	Material
	22	30	100	9 113 565

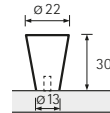

Agrinum



Edelstahl gebürstet
Brushed stainless steel
Inox brossé
Roestvrij staal geborsteld

Ø	H	Weight	Material
14	22	200	9 070 263
18	26	125	9 070 264



Monacum



Edelstahl gebürstet
Brushed stainless steel
Inox brossé
Roestvrij staal geborsteld

Ø	H	Weight	Material
10	20	200	9 070 957
14	15	150	9 070 958



Danum



Edelstahl gebürstet
Brushed stainless steel
Inox brossé
Roestvrij staal geborsteld

\varnothing_1	\varnothing_2	\pm		
20	11	18	9 070 744	150
25	14	22	9 070 740	125
30	16	26	9 070 735	75



Sion



Edelstahl gebürstet
Brushed stainless steel
Inox brossé
Roestvrij staal geborsteld

			9 113 564	100

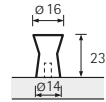

Spalatum



Edelstahl gebürstet
Brushed stainless steel
Inox brossé
Roestvrij staal geborsteld

			9 070 580	100

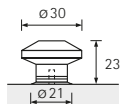

DELUXE



42 Amisia



42 Limpio



43 Istrana



43 Itri



44 Forli



44 Brema



45 Como

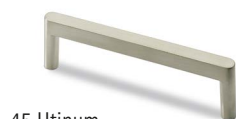

45 Utinum



46 Buena



47 Baldone



47 Belluno



48 Cecina



48 Ponte



49 Intra



50 Veronia



50 Basilia



51 Arimini



51 Opera



51 Saturnia



52 Delia



52 Lodi



52 Sava



53 Solda

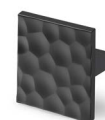

53 Londa



54 Fogo



54 Bona



DELUXE

Amisia



- 1 Verchromt glanz
Bright chrome plated
Chromé brillant
Verchroomd glans



- 2 Edelstahl Optik gebürstet
Brushed stainless steel look
Aspect inox brossé
Roestvrij staal finish geborsteld

1	9 190 446	25	
2	9 190 445	25	

Limpio



- 1 Weiß matt
Matt White
Blanc mat
Wit mat



- 2 Schwarz matt
Matt black
Noir mat
Zwart mat

1	9 266 417	25	
2	9 266 418	25	

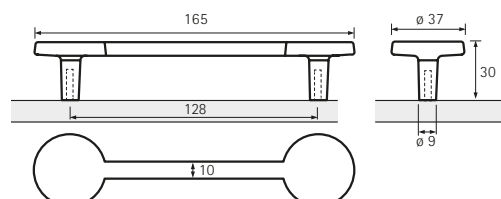
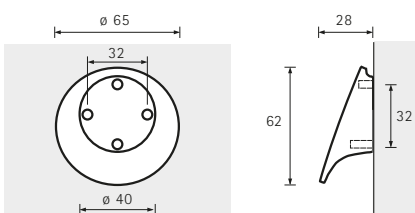

Istrana



Edelstahl Optik gebürstet
Brushed stainless steel look
Aspect inox brossé
Roestvrij staal finish geborsteld

Itri



Edelstahl Optik gebürstet
Brushed stainless steel look
Aspect inox brossé
Roestvrij staal finish geborsteld

DELUXE

9 132 312 25

9 132 314 30

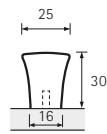
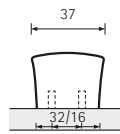
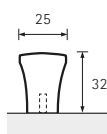
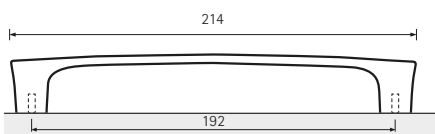

DELUXE

Forli



- 1 Verchromt glanz
Bright chrome plated
Chromé brillant
Verchroomd glans



- 2 Edelfstahl Optik gebürstet
Brushed stainless steel look
Aspect inox brossé
Roestvrij staal finish geborsteld

		□
1	9 112 660	35
2	9 207 488	35



Brema



- 1 Edelfstahl gebürstet /
Edelfstahl Optik gebürstet
Brushed stainless steel /
Brushed stainless steel look
Inox brossé / Aspect inox brossé
Roestvrij staal geborsteld /
Roestvrij staal finish geborsteld



- 2 Schwarz matt /
Edelfstahl Optik gebürstet
Matt black /
Brushed stainless steel look
Noir mat / Aspect inox brossé
Zwart mat /
Roestvrij staal finish geborsteld

	•••	•		□		•••	•		□
1	96	108	9 118 858	25	2	96	108	9 264 074	25
1	128	140	9 069 890	25	2	128	140	9 264 075	25
1	160	172	9 069 893	25	2	160	172	9 264 076	25
1	192	204	9 070 104	25	2	192	204	9 264 077	25
1	224	236	9 070 106	25	2	224	236	9 264 078	25
1	256	268	9 070 107	30	2	256	268	9 264 079	30
1	288	300	9 070 108	30	2	288	300	9 264 080	30
1	352	364	9 070 109	20	2	352	364	9 264 081	20
1	416	428	9 070 110	20	2	416	428	9 264 082	20
1	448	460	9 070 112	20	2	448	460	9 264 084	20
1	640	652	9 070 113	15	2	640	652	9 264 085	15

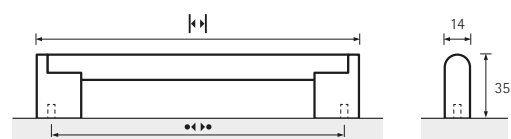

Como



1 Edelstahl gebürstet /
Edelstahl Optik gebürstet
Brushed stainless steel /
Brushed stainless steel look
Inox brossé / Aspect inox brossé
Roestvrij staal geborsteld /
Roestvrij staal finish geborsteld



2 Schwarz matt
Matt black
Noir mat
Zwart mat

Utinum



Edelstahl Optik gebürstet
Brushed stainless steel look
Aspect inox brossé
Roestvrij staal finish geborsteld

	•••			□
1	192	204	0 115 077	25
1	320	332	0 115 078	20
2	192	204	9 264 072	25
2	320	332	9 264 073	20

	□
	9 109 703 50

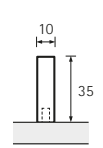
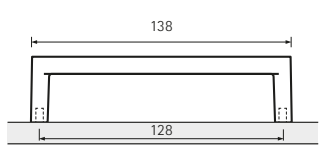
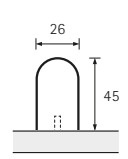
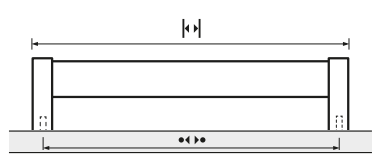

DELUXE

Buena



Kupfer Optik glanz
Bright copper look
Aspect cuivre brillant
Koperkleurig glanzend

9 207 444 75

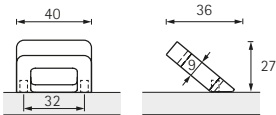

Kupfer Optik glanz
Bright copper look
Aspect cuivre brillant
Koperkleurig glanzend

9 207 445 25

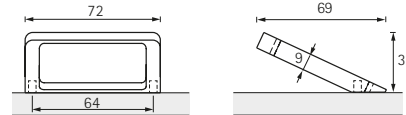

Kupfer Optik glanz
Bright copper look
Aspect cuivre brillant
Koperkleurig glanzend

9 207 446 30

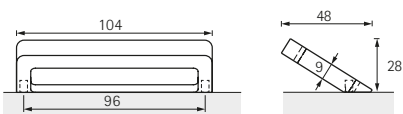

Kupfer Optik glanz
Bright copper look
Aspect cuivre brillant
Koperkleurig glanzend

9 207 447 35

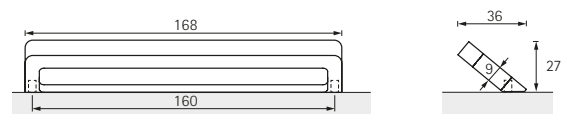

Baldone



1 Verchromt glanz
Bright chrome plated
Chromé brillant
Verchromd glans



2 Verchromt matt
Matt chrome plated
Chromé mat
Verchromd mat



3 Edelfstahl Optik gebürstet
Brushed stainless steel look
Aspect inox brossé
Roestvrij staal finish geborsteld



4 Schwarz matt
Matt black
Noir mat
Zwart mat

Belluno



1 Verchromt glanz
Bright chrome plated
Chromé brillant
Verchromd glans



2 Verchromt matt
Matt chrome plated
Chromé mat
Verchromd mat



3 Edelfstahl Optik gebürstet
Brushed stainless steel look
Aspect inox brossé
Roestvrij staal finish geborsteld



4 Schwarz matt
Matt black
Noir mat
Zwart mat

	••	• ₁	• ₂	±	□
1	96	104	11	26	9 995 546 40
1	128	136	11	26	9 995 547 30
1	160	168	11	26	9 995 780 30
1	256	264	15	29	9 995 548 25
2	96	104	11	26	9 995 482 40
2	128	136	11	26	9 995 480 30
2	160	168	11	26	9 995 782 30
2	256	264	15	29	9 995 484 25
3	96	104	11	26	9 995 483 40
3	128	136	11	26	9 995 481 30
3	160	168	11	26	9 995 781 30
3	256	264	15	29	9 995 485 25
4	96	104	11	26	9 269 733 40
4	128	136	11	26	9 269 734 30
4	160	168	11	26	9 269 735 30
4	256	264	15	29	9 269 736 25

	••	•	±	□
1	96	130	28	0 043 643 30
1	160 / 192	200	30	0 043 503 40
1	224 / 256	267	30	0 043 506 25
2	96	130	28	0 043 642 30
2	160 / 192	200	30	0 043 502 40
2	224 / 256	267	30	0 043 505 25
3	96	130	28	9 995 771 30
3	160 / 192	200	30	9 995 772 40
3	224 / 256	267	30	9 995 773 25
4	96	130	28	9 270 437 30
4	160 / 192	200	30	9 270 438 40
4	224 / 256	267	30	9 270 439 25

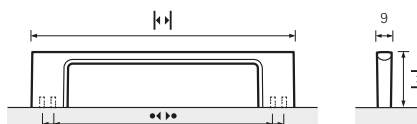
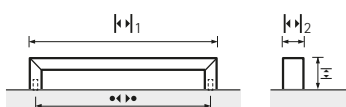

DELUXE

Cecina



1 Champagner / Edelstahl gebürstet
 Champagne / Brushed stainless steel
 Champagne / Inox brossé
 Champagne / Roestvrij staal geborsteld



2 Rot / Edelstahl gebürstet
 Red / Brushed stainless steel
 Rouge / Inox brossé
 Rood / Roestvrij staal geborsteld



3 Blau / Edelstahl gebürstet
 Blue / Brushed stainless steel
 Bleu / Inox brossé
 Blauw / Roestvrij staal geborsteld



4 Anthrazit / Edelstahl gebürstet
 Anthracite / Brushed stainless steel
 Anthracite / Inox brossé
 Antraciet / Roestvrij staal geborsteld

		☐
1	9 199 093	10
2	9 199 030	10
3	9 199 091	10
4	9 199 092	10

Ponte



Edelstahl gebürstet
 Brushed stainless steel
 Inox brossé
 Roestvrij staal geborsteld

•••			☐
160	173	0 115 385	25
192	205	0 115 060	50
320	333	0 115 387	20

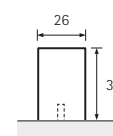
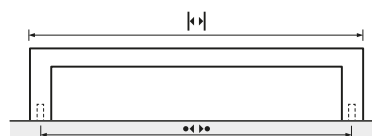
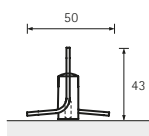
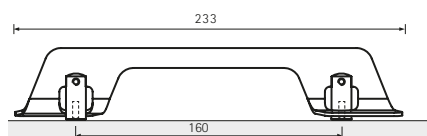

Intra



1 Verchromt glanz / Verchromt matt
Bright chrome plated /
Matt chrome plated
Chromé brillant / Chromé mat
Verchromd glans /
Verchromd mat



5 Edelstahl Optik gebürstet /
Kupfer Optik gebürstet
Brushed stainless steel look /
Brushed copper look
Aspect inox brossé /
Aspect cuivre brossé
Roestvrij staal finish geborsteld /
Koperkleurig geborsteld



2 Verchromt matt / Verchromt glanz
Matt chrome plated /
Bright chrome plated
Chromé mat / Chromé brillant
Verchromd mat /
Verchromd glans



6 Weiß matt / Kupfer Optik gebürstet
Matt white / Brushed copper look
Blanc mat / Aspect cuivre brossé
Wit mat / Koperkleurig geborsteld



3 Edelstahl Optik gebürstet /
Verchromt glanz
Brushed stainless steel look /
Bright chrome plated
Aspect inox brossé / Chromé brillant
Roestvrij staal finish geborsteld /
Verchromd glans



7 Schwarz matt /
Edelstahl Optik gebürstet
Matt black /
Brushed stainless steel look
Noir mat / Aspect inox brossé
Zwart mat /
Roestvrij staal finish geborsteld



4 Edelstahl Optik gebürstet
Brushed stainless steel look
Aspect inox brossé
Roestvrij staal finish geborsteld



8 Schwarz matt /
Kupfer Optik gebürstet
Matt black /
Brushed copper look
Noir mat / Aspect cuivre brossé
Zwart mat /
Koperkleurig geborsteld

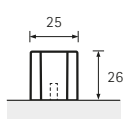
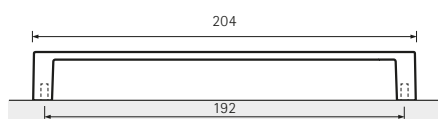

		☐
1	9 113 800	25
2	9 105 737	25
3	9 105 735	25
4	9 207 482	25

		☐
5	9 207 480	25
6	9 207 483	25
7	9 207 481	25
8	9 264 088	25

DELUXE

Veronia



1 Verchromt glanz
Bright chrome plated
Chromé brillant
Verchromd glans



2 Edeldahl Optik gebürstet
Brushed stainless steel look
Aspect inox brossé
Roestvrij staal finish geborsteld

Basilia



Edeldahl Optik gebürstet
Brushed stainless steel look
Aspect inox brossé
Roestvrij staal finish geborsteld

	•••	k 1	k 2		□
1	128	144	14	9 065 634	50
1	160	176	19	9 097 947	25
2	128	144	14	9 065 635	50
2	160	176	19	9 097 946	25

	□
	0 115 076 25

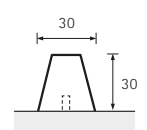
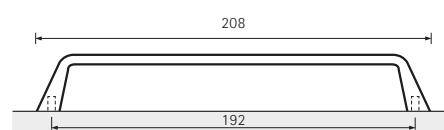
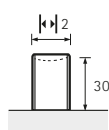
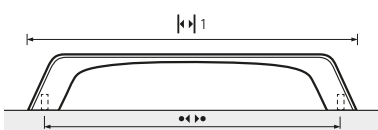

Arimini



1 Verchromt glanz / Weiß
Bright chrome plated / White
Chromé brillant / Blanc
Verchromd glans / Wit



2 Verchromt glanz / Schwarz
Bright chrome plated / Black
Chromé brillant / Noir
Verchromd glans / Zwart

1	9 113 719	100	
2	9 112 664	100	

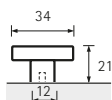

Opera



Verchromt glanz
Bright chrome plated
Chromé brillant
Verchromd glans

•••			
96/128	135	9 113 675	50
160	200	9 113 678	25
192	232	9 113 681	25

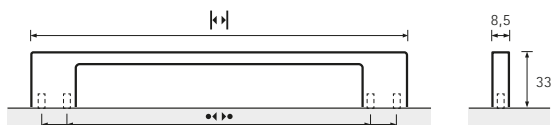

Saturnia



Verchromt glanz
Bright chrome plated
Chromé brillant
Verchromd glans

	9 113 712	50

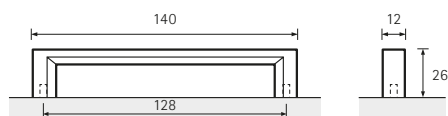

DELUXE

Delia



Verchromt glanz
Bright chrome plated
Chromé brillant
Verchromd glans

•••	•		☐
128	144	9 113 685	50
160	176	9 113 690	50

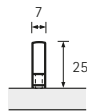
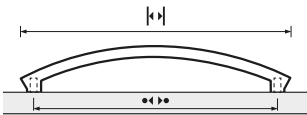

Lodi



1 Verchromt glanz
Bright chrome plated
Chromé brillant
Verchromd glans



2 Gold Optik
Gold look
Aspect or
Goudkleurig

		☐
1	9 113 699	50
2	9 113 700	50

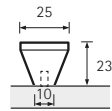

Sava



Verchromt glanz
Bright chrome plated
Chromé brillant
Verchromd glans

		☐
	9 113 696	50

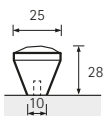

Solda



1 Verchromt glanz
Bright chrome plated
Chromé brillant
Verchromd glans

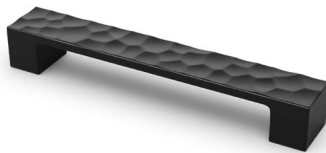

2 Schwarz matt
Matt black
Noir mat
Zwart mat

Londa



1 Verchromt glanz
Bright chrome plated
Chromé brillant
Verchromd glans

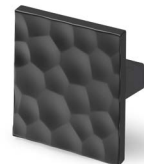

2 Schwarz matt
Matt black
Noir mat
Zwart mat

		☐
1	9 113 404	20
2	9 269 741	20

		☐
1	9 113 397	20
2	9 269 742	20

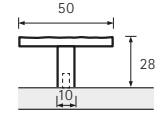
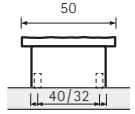
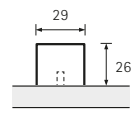
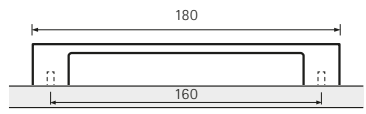

DELUXE

Fogo



Edelstahl Optik gebürstet
Brushed stainless steel look
Aspect inox brossé
Roestvrij staal finish geborsteld

Bona



1 Verchromt glanz
Bright chrome plated
Chromé brillant
Verchromd glans



2 Edelstahl Optik gebürstet
Brushed stainless steel look
Aspect inox brossé
Roestvrij staal finish geborsteld

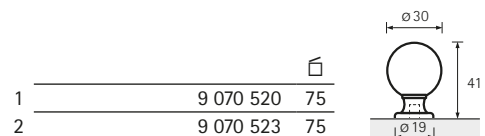

ORGANIC



58 Neapolis



58 Tolfo



58 Athena



59 Borgoa



59 Oli



60 Aboa



60 Felina



61 Coria



61 Parma



62 Balmo



62 Carvo



63 Nicia



64 Bathia



64 Matilo



65 Salona



65 Ovada



66 Fectio



66 Vantania



67 Tolosa



67 Dinia



68 Naila



68 Culmen



69 Vada



70 Avenio



71 Asopus



71 Belna

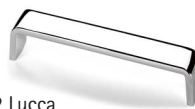

72 Lucca



72 Catana



73 Chalcis



73 Vieste



74 Suasa



74 Carolina



75 Trento



75 Meana



76 Codania



77 Tardiano



77 Ladera



77 Issa



77 Sipontum



78 Sala



78 Almus



79 Cirpi



79 Serbinum



79 Murcia

ORGANIC

Neapolis



- 1 Verchromt glanz
Bright chrome plated
Chromé brillant
Verchroomd glans



- 2 Edelstahl Optik gebürstet
Brushed stainless steel look
Aspect inox brossé
Roestvrij staal finish geborsteld

		□
1	0 115 122	25
2	9 114 747	25

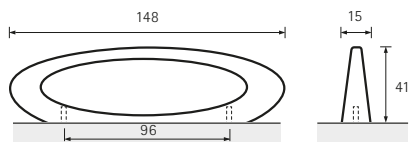

Tolfo



- 1 Verchromt glanz
Bright chrome plated
Chromé brillant
Verchroomd glans



- 2 Edelstahl Optik gebürstet
Brushed stainless steel look
Aspect inox brossé
Roestvrij staal finish geborsteld

		□
1	9 097 900	25
2	9 097 899	25

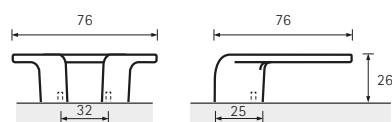

Athena



- 1 Verchromt glanz
Bright chrome plated
Chromé brillant
Verchroomd glans



- 2 Aluminium Optik
Aluminium look
Aspect aluminium
Aluminiumkleurig

		□
1	9 065 425	20
2	9 065 427	20
3	9 065 426	20



- 3 Edelstahl Optik gebürstet
Brushed stainless steel look
Aspect inox brossé
Roestvrij staal finish geborsteld

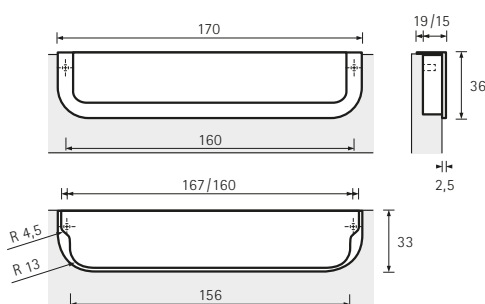

Borgoa



- 1 Verchromt glanz
Bright chrome plated
Chromé brillant
Verchromd glans



- 2 Verchromt matt
Matt chrome plated
Chromé mat
Verchromd mat



- 3 Vernickelt matt
Matt nickel plated
Nickelé mat
Vernikkeld mat



- 4 Edelfstahl Optik
Stainless steel look
Aspect inox
Roestvrij staal finish

1	9 070 574	75	☐
2	9 070 567	75	
3	9 070 565	75	
4	9 070 556	75	

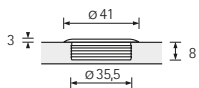

Olivia



- 1 Verchromt glanz
Bright chrome plated
Chromé brillant
Verchromd glans



- 2 Aluminium Optik
Aluminium look
Aspect aluminium
Aluminiumkleurig



- 3 Schwarz matt
Matt black
Noir mat
Zwart mat

1	9 277 179	15	☐
2	9 266 415	15	
3	9 266 416	15	

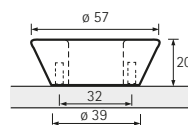

ORGANIC

Aboa



- 1 Edelstahl gebürstet
Brushed stainless steel
Inox brossé
Roestvrij staal geborsteld



- 2 Edelstahl gebürstet / Schwarz glänzend
Brushed stainless steel / Polished black
Inox brossé / Noir brillant
Roestvrij staal geborsteld / Zwart glanzend

			☐
1	9 070 138	25	
2	9 207 534	25	

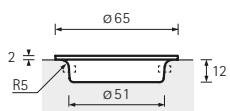

Felina



- 1 Verchromt glanz
Bright chrome plated
Chromé brillant
Verchromd glans



- 2 Edelstahl Optik gebürstet
Brushed stainless steel look
Aspect inox brossé
Roestvrij staal finish geborsteld



- 3 Schwarz matt
Matt black
Noir mat
Zwart mat

			☐
1	9 113 373	15	
2	9 113 371	15	
3	9 265 887	15	

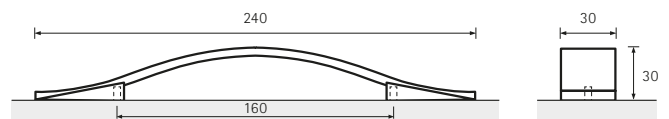

Coria



- 1 Verchromt glanz
Bright chrome plated
Chromé brillant
Verchromd glans



- 2 Verchromt matt
Matt chrome plated
Chromé mat
Verchromd mat



- 3 Vernickelt matt
Matt nickel plated
Nickelé mat
Vernikkeld mat



- 4 Edelfstahl Optik gebürstet
Brushed stainless steel look
Aspect inox brossé
Roestvrij staal finish geborsteld

1	9 070 624	50	
2	9 112 597	50	
3	9 112 596	50	
4	9 112 595	50	

Parma



- 1 Verchromt glanz
Bright chrome plated
Chromé brillant
Verchromd glans



- 2 Edelfstahl Optik gebürstet
Brushed stainless steel look
Aspect inox brossé
Roestvrij staal finish geborsteld

1	9 113 468	50	
2	9 113 467	50	

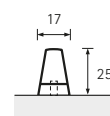
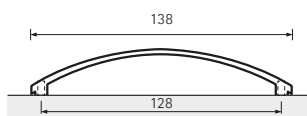
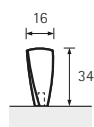
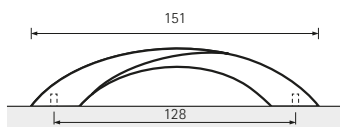

ORGANIC

Balmo



- 1 Verchromt matt
Matt chrome plated
Chromé mat
Verchromd mat



- 2 Edeldahl Optik gebürstet
Brushed stainless steel look
Aspect inox brossé
Roestvrij staal finish geborsteld

Carvo



- Edeldahl Optik gebürstet
Brushed stainless steel look
Aspect inox brossé
Roestvrij staal finish geborsteld

1	0 074 134	25
2	0 043 472	25

9 112 623	50
-----------	----

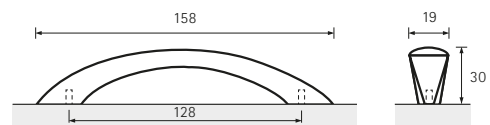
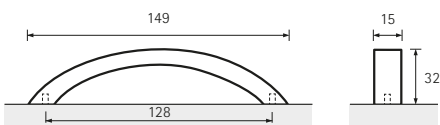

Nicia



- 1 Verchromt glanz
Bright chrome plated
Chromé brillant
Verchromd glans

	•••		≡		□
1	96	112	30	9 070 983	50
1	128	148	30	9 071 037	50
1	160	184	32	9 070 997	50
1	192	221	32	9 071 018	50
1	224	258	32	9 071 049	



- 2 Verchromt matt
Matt chrome plated
Chromé mat
Verchromd mat

2	96	112	30	9 070 986	50
2	128	148	30	9 071 039	50
2	160	184	32	9 071 001	50
2	192	221	32	9 070 784	50
2	224	258	32	9 071 063	50



- 3 Vernickelt matt
Matt nickel plated
Nickelé mat
Vernikkeld mat

3	96	112	30	9 071 014	50
3	128	148	30	9 070 976	50
3	160	184	32	9 071 016	50
3	192	221	32	9 071 019	50
3	224	258	32	9 070 980	50



- 4 Edsstahl Optik gebürstet
Brushed stainless steel look
Aspect inox brossé
Roestvrij staal finish geborsteld

4	96	112	30	9 070 985	50
4	128	148	30	9 071 067	50
4	160	184	32	9 070 722	50
4	192	221	32	9 070 723	50
4	224	258	32	9 071 068	50

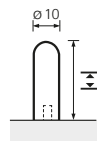
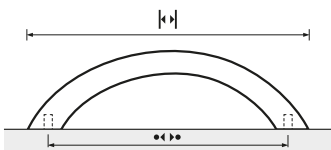

ORGANIC

Bathia



- 1 Verchromt glanz
Bright chrome plated
Chromé brillant
Verchroomd glans



- 2 Edeldahl Optik gebürstet
Brushed stainless steel look
Aspect inox brossé
Roestvrij staal finish geborsteld

Matilo



- 1 Verchromt matt
Matt chrome plated
Chromé mat
Verchroomd mat



- 2 Vernickelt matt
Matt nickel plated
Nickelé mat
Vernikkeld mat



- 3 Edeldahl Optik gebürstet
Brushed stainless steel look
Aspect inox brossé
Roestvrij staal finish geborsteld

	•••	•		□
1	96	118	9 070 492	50
1	128	151	9 070 508	50
2	96	118	9 070 493	50
2	128	151	9 070 516	50

		□
1	9 112 914	50
2	0 115 195	50
3	9 206 642	50

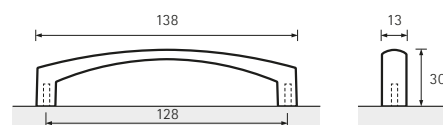
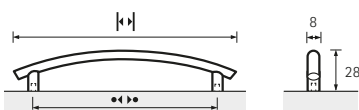

Salona



Edelstahl Optik gebürstet
Brushed stainless steel look
Aspect inox brossé
Roestvrij staal finish geborsteld

Ovada



1 Verchromt glanz
Bright chrome plated
Chromé brillant
Verchromd glans



2 Edelstahl Optik gebürstet
Brushed stainless steel look
Aspect inox brossé
Roestvrij staal finish geborsteld

				☐
1	170	155	30	

		☐	☐			☐
1	96	139	9 118 524	50		
1	160 / 192	266	9 118 521	50		
1	256 / 320	362	9 118 518	25		
2	96	139	9 118 523	50		
2	160 / 192	266	9 118 520	50		
2	256 / 320	362	9 118 517	25		

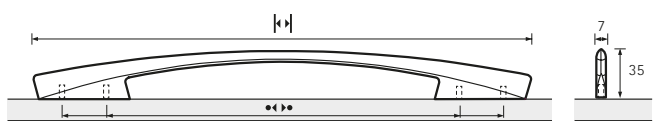
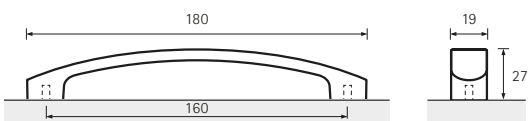

ORGANIC

Fectio



- 1 Verchromt matt
Matt chrome plated
Chromé mat
Verchromd mat



- 2 Edelfstahl Optik gebürstet
Brushed stainless steel look
Aspect inox brossé
Roestvrij staal finish geborsteld

	□	
1	9 112 615	50
2	9 112 613	50

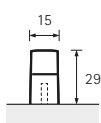
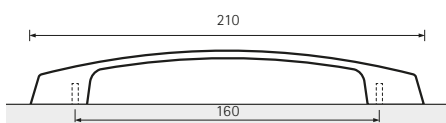

Vantania



- 1 Verchromt glanz
Bright chrome plated
Chromé brillant
Verchromd glans



- 2 Verchromt matt
Matt chrome plated
Chromé mat
Verchromd mat



- 3 Edelfstahl Optik gebürstet
Brushed stainless steel look
Aspect inox brossé
Roestvrij staal finish geborsteld

	□	
1	9 113 211	25
2	9 113 210	25
3	1 170 158	25

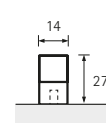
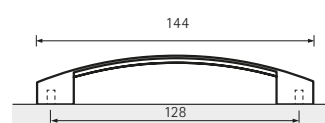

Tolosa



- 1 Verchromt matt
Matt chrome plated
Chromé mat
Verchromd mat



- 2 Vernickelt matt
Matt nickel plated
Nickelé mat
Vernikkeld mat

Dinia



- 1 Verchromt matt
Matt chrome plated
Chromé mat
Verchromd mat



- 2 Edielstahl Optik gebürstet
Brushed stainless steel look
Aspect inox brossé
Roestvrij staal finish geborsteld

	•••			□
1	96	126	9 112 910	30
1	128	157	9 112 909	25
2	96	126	0 115 203	30
2	128	157	9 113 514	25

	•••	₁	₂	□	□
1	96	118	16 28	9 070 754	75
1	128	143	18 29	9 070 752	50
2	96	118	16 28	9 070 675	75
2	128	143	18 29	9 070 681	50

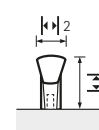
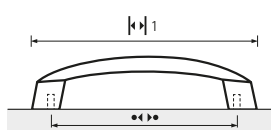
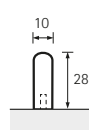
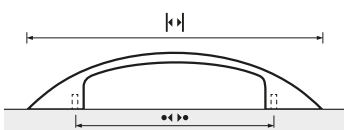

ORGANIC

Naila



1 Aluminium eloxiert
Aluminium, anodised
Aluminium anodisé
Aluminium geëloxeerd



2 Braun metallic gebürstet
Brown metallic brushed
Brun métallique brossé
Bruin metallic geborsteld



3 Schwarz matt
Matt black
Noir mat
Zwart mat

	•••	•		□
1	64	71	9 190 399	50
1	96	103	9 190 421	50
1	128	135	9 190 422	50
1	160	167	9 190 423	50
1	192	199	9 190 424	50
1	256	263	9 190 425	50
1	288	295	9 190 426	50
1	320	327	9 190 427	50
2	64	71	9 190 428	50
2	96	103	9 190 429	50
2	128	135	9 190 430	50
2	160	167	9 190 431	50
2	192	199	9 190 432	50
2	256	263	9 190 433	50
2	288	295	9 190 434	50
2	320	327	9 190 435	50

	•••	•		□
3	64	71	9 266 077	50
3	96	103	9 266 078	50
3	128	135	9 266 079	50
3	160	167	9 266 080	50
3	192	199	9 266 091	50
3	256	263	9 266 092	50
3	288	295	9 266 093	50
3	320	327	9 266 094	50

Culmen



1 Aluminium eloxiert
Aluminium, anodised
Aluminium anodisé
Aluminium geëloxeerd



2 Edelstahl Optik gebürstet
Brushed stainless steel look
Aspect inox brossé
Roestvrij staal finish geborsteld

	•••	•		□
1	96	104	0 115 146	50
1	128	136	0 115 147	50
1	160	168	0 115 148	50
1	192	200	0 115 149	50
1	224	232	0 115 150	50
1	288	296	0 115 152	50
1	352	360	0 115 153	25
2	96	104	9 206 115	50
2	128	136	9 206 116	50
2	160	168	9 206 117	50
2	192	200	9 206 119	50
2	224	232	9 206 120	50
2	288	296	9 206 122	50
2	352	360	9 206 124	25

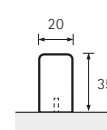
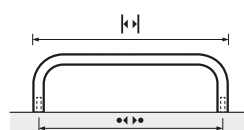
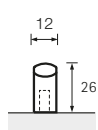
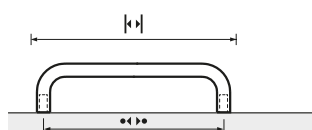

Vada



Edelstahl gebürstet
 Brushed stainless steel
 Inox brossé
 Roestvrij staal geborsteld

«»	«»	☐		☐
64	75	30	9 070 440	75
96	111	30	9 070 446	50
128	149	30	9 070 501	50
160	184	32	9 070 451	50
192	222	32	9 070 457	50
224	260	32	9 070 504	50
256	297	32	9 070 466	50
288	335	32	9 070 509	50
320	368	34	9 070 481	50
352	392	41	9 070 494	50

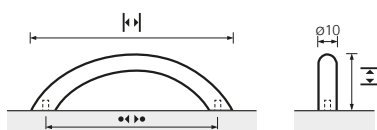

ORGANIC

Avenio



1 Verchromt glanz
Bright chrome plated
Chromé brillant
Verchromd glans



2 Verchromt matt
Matt chrome plated
Chromé mat
Verchromd mat



3 Vernickelt matt
Matt nickel plated
Nickelé mat
Vernikkeld mat



4 Edelfstahl Optik gebürstet
Brushed stainless steel look
Aspect inox brossé
Roestvrij staal finish geborsteld

	Ø	•••			□
1	8	64	72	9 070 605	50
1	8	96	104	9 070 602	50
1	8	128	136	9 070 075	50
1	10	64	74	9 070 443	50
1	10	96	106	9 070 519	50
1	10	128	138	9 070 625	50
1	10	160	170	9 070 548	75
1	10	192	202	9 069 899	50
1	10	288	298	9 069 922	50
1	10	352	362	9 069 900	25
2	8	64	72	9 069 943	50
2	8	96	104	9 070 054	50
2	8	128	136	9 070 078	50
2	10	64	74	9 070 444	50
2	10	96	106	9 070 521	50
2	10	128	138	9 070 540	50
2	10	160	170	9 070 552	75
2	10	192	202	9 070 572	50
2	10	288	298	9 069 877	50
2	10	352	362	9 069 892	25
3	8	64	72	9 069 919	50
3	8	96	104	9 069 915	50
3	8	128	136	9 069 907	50
3	10	64	74	9 070 511	50
3	10	96	106	9 070 522	50
3	10	128	138	9 070 619	50
3	10	160	170	9 069 909	75
3	10	192	202	9 069 868	50
3	10	288	298	9 069 867	50
3	10	352	362	9 069 873	25
4	8	64	72	9 070 030	50
4	8	96	104	9 070 439	50
4	8	128	136	9 070 429	50
4	10	64	74	9 070 512	50
4	10	96	106	9 070 527	50
4	10	128	138	9 070 448	50
4	10	160	170	9 070 557	75
4	10	192	202	9 070 577	50
4	10	288	298	9 069 927	50
4	10	352	362	9 070 025	25

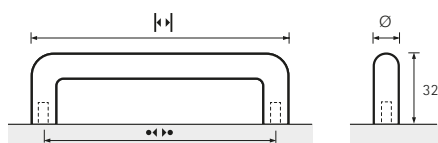

Asopus



Edelstahl gebürstet
Brushed stainless steel
Inox brossé
Roestvrij staal geborsteld

Belna



Edelstahl Optik gebürstet
Brushed stainless steel look
Aspect inox brossé
Roestvrij staal finish geborsteld

Ø	•••		≡		□
8	64	72	32	9 070 096	50
8	96	104	32	9 069 942	50
8	128	136	32	9 070 101	50
10	96	106	32	9 069 815	50
10	128	138	32	9 069 818	50
10	160	170	32	9 070 124	75
10	192	202	32	9 070 420	50
10	224	234	32	9 069 821	50
10	320	330	32	9 069 865	50
10	352	362	32	9 070 421	25
12	96	108	40	9 070 102	50
12	128	140	40	9 070 103	50
12	160	172	40	9 070 117	50
12	192	204	40	9 070 105	50
12	224	236	40	9 070 118	50
12	320	332	40	9 070 119	50
12	352	364	40	9 070 111	25
12	480	492	40	9 070 120	25
12	704	716	40	9 070 122	25

•••			□
128	135	0 115 169	50
160	167	0 115 170	50

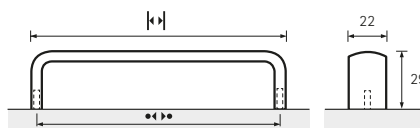
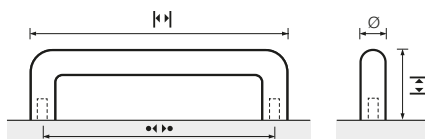

ORGANIC

Lucca

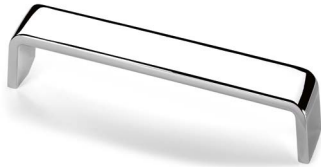

- 1 Verchromt glanz
Bright chrome plated
Chromé brillant
Verchroomd glans



- 2 Edelstahl Optik gebürstet
Brushed stainless steel look
Aspect inox brossé
Roestvrij staal finish geborsteld

			☐
1	9 113 510	25	
2	9 113 511	25	

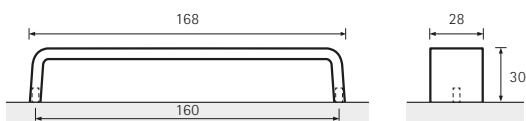

Catana



- 1 Aluminium eloxiert
Aluminium, anodised
Aluminium anodisé
Aluminium geëloxeerd



- 2 Edelstahl Optik gebürstet
Brushed stainless steel look
Aspect inox brossé
Roestvrij staal finish geborsteld

	•••	•		☐
1	192	199	9 113 733	25
1	320	327	9 113 734	25
2	192	199	0 115 080	25
2	320	327	0 115 081	25

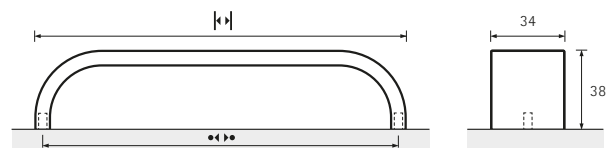

Chalcis



Edelstahl Optik gebürstet
Brushed stainless steel look
Aspect inox brossé
Roestvrij staal finish geborsteld

Vieste



Edelstahl Optik gebürstet
Brushed stainless steel look
Aspect inox brossé
Roestvrij staal finish geborsteld

•••	•		□
128	147	9 113 183	40
288	301	9 113 182	40

•••	•		□
96	120	9 995 497	20
128	152	9 995 498	15
160	184	9 995 499	25
192	216	9 995 500	20
224	248	9 995 501	20

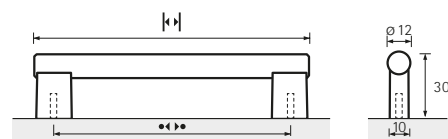
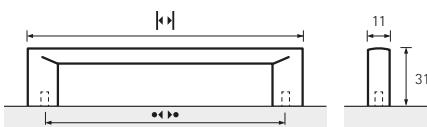

ORGANIC

Suasa



- 1 Verchromt glanz
Bright chrome plated
Chromé brillant
Verchroomd glans



- 2 Edeltahl Optik gebürstet
Brushed stainless steel look
Aspect inox brossé
Roestvrij staal finish geborsteld

			☐
1	9 112 916	25	
2	9 112 915	25	

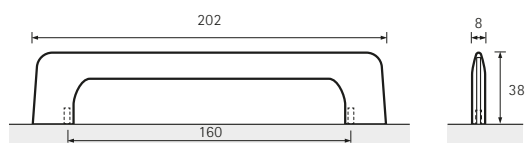

Carolina



- 1 Verchromt glanz
Bright chrome plated
Chromé brillant
Verchroomd glans



- 2 Edeltahl Optik gebürstet
Brushed stainless steel look
Aspect inox brossé
Roestvrij staal finish geborsteld

			☐
1	9 080 858	50	
2	9 080 859	50	

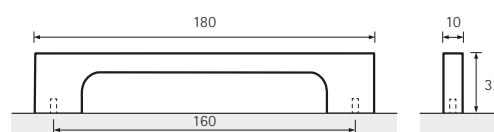

Trento



- 1 Verchromt glanz
Bright chrome plated
Chromé brillant
Verchromd glans



- 2 Edalstahl Optik gebürstet
Brushed stainless steel look
Aspect inox brossé
Roestvrij staal finish geborsteld

Meana



- Edalstahl Optik gebürstet
Brushed stainless steel look
Aspect inox brossé
Roestvrij staal finish geborsteld

	•••	•		□
1	32	93	9 070 095	100
1	96	171	9 070 123	50
2	32	93	9 070 121	100
2	96	171	9 070 125	50

	□
	9 114 539 25

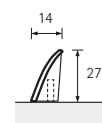
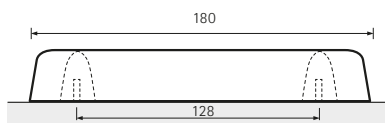
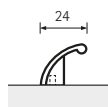
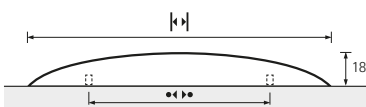

ORGANIC

Codania



- 1 Edelstahl Optik gebürstet
Brushed stainless steel look
Aspect inox brossé
Roestvrij staal finish geborsteld



- 2 Schwarz matt
Matt black
Noir mat
Zwart mat



- 3 Gold Optik matt gebürstet
Gold look matt brushed
Aspect doré brossé mat
Goudkleurig mat geborsteld

	k ₁	k ₂		□		k ₁	k ₂		□		k ₁	k ₂		□
1	295	236	9 209 994	50	2	295	236	9 265 997	50	3	295	236	9 266 067	50
1	345	275	9 209 995	25	2	345	275	9 265 998	25	3	345	275	9 266 068	25
1	395	315	9 209 996	25	2	395	315	9 265 999	25	3	395	315	9 266 069	25
1	445	355	9 209 997	25	2	445	355	9 266 000	25	3	445	355	9 266 070	25
1	495	395	9 210 058	25	2	495	395	9 266 001	25	3	495	395	9 266 071	25
1	595	475	9 210 059	25	2	595	475	9 266 002	25	3	595	475	9 266 072	25
1	795	635	9 210 060	25	2	795	635	9 266 003	25	3	795	635	9 266 073	25
1	895	715	9 210 061	25	2	895	715	9 266 004	25	3	895	715	9 266 074	25
1	995	795	9 210 062	25	2	995	795	9 266 005	25	3	995	795	9 266 075	25
1	1195	954	9 210 063	20	2	1195	954	9 266 006	20	3	1195	954	9 266 076	20

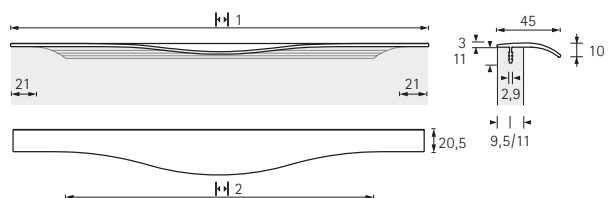

Tardiano



- 1 Edeldstahl Optik gebürstet
Brushed stainless steel look
Aspect inox brossé
Roestvrij staal finish geborsteld



- 2 Schwarz matt
Matt black
Noir mat
Zwart mat

1	9 266 141	25
2	9 266 142	25

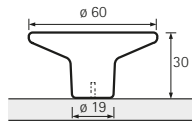

Ladera



- Vernickelt matt
Matt nickel plated
Nickelé mat
Vernikkeld mat

	9 112 644	50
--	-----------	----

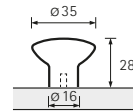

Issa



- 1 Verchromt glanz
Bright chrome plated
Chromé brillant
Verchromd glans



- 2 Edeldstahl Optik gebürstet
Brushed stainless steel look
Aspect inox brossé
Roestvrij staal finish geborsteld



- 3 Schwarz matt
Matt black
Noir mat
Zwart mat

1	9 203 958	50
2	0 115 312	50
3	9 265 885	50

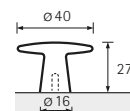

Sipontum



- Edeldstahl gebürstet
Brushed stainless steel
Inox brossé
Roestvrij staal geborsteld

	9 070 568	75
--	-----------	----

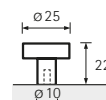

ORGANIC

Sala



- 1 Verchromt glanz
Bright chrome plated
Chromé brillant
Verchromd glans



- 2 Messing Optik glanz
Bright brass look
Aspect laiton brillant
Messingkleurig glanzend

1	9 071 110	75
2	9 071 109	75

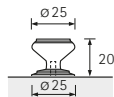

Almus



- 1 Verchromt glanz
Bright chrome plated
Chromé brillant
Verchromd glans



- 2 Verchromt matt
Matt chrome plated
Chromé mat
Verchromd mat



- 3 Vernickelt matt
Matt nickel plated
Nickelé mat
Vernikkeld mat



- 4 Edeldstahl Optik gebürstet
Brushed stainless steel look
Aspect inox brossé
Roestvrij staal finish geborsteld



- 5 Kupfer Optik glanz
Bright copper look
Aspect cuivre brillant
Koperkleurig glanzend

1	9 112 583	50
2	9 112 590	50
3	9 112 588	50
4	9 114 036	50
5	9 204 136	50

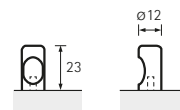

Cirpi



1 Weiß
White
Blanc
Wit



2 Verchromt glanz
Bright chrome plated
Chromé brillant
Verchromd glans



3 Verchromt matt
Matt chrome plated
Chromé mat
Verchromd mat



4 Vernickelt matt
Matt nickel plated
Nickelé mat
Vernikkeld mat



5 Edelstahl Optik gebürstet
Brushed stainless steel look
Aspect inox brossé
Roestvrij staal finish geborsteld

1	9 070 589	30
2	9 070 585	30
3	9 070 581	30
4	9 070 586	30
5	9 206 738	30

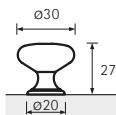

Serbinum



Edelstahl gebürstet
Brushed stainless steel
Inox brossé
Roestvrij staal geborsteld

9 070 562	75
-----------	----

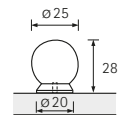

Murcia



Verchromt glanz
Bright chrome plated
Chromé brillant
Verchromd glans

9 207 443	75
-----------	----

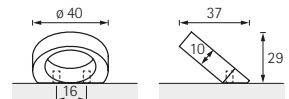

FOLK



82 Cato



82 Calili



83 Ponzone



83 Ponti



84 Corduba



84 Vesontio



84 Ponoka



84 Oka



85 Luro



85 Tarraco



85 Pomezia



85 Potovio



86 Barcino



86 Bracara



86 Olisipo



87 Arezzo

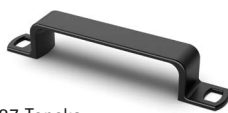

87 Topeka



88 Siradia



88 Sertao



89 Haida



89 Terranda



89 Gissi



89 Osimo



90 Malaca



90 Valentia



91 Egara



91 Bruxella



92 Salacia



92 Eburaco



92 Savelli



92 Salemi



93 Alberta



93 Ogulin



94 Meduno



94 Flavia



94 Emo



95 Bevipo



95 Dipo



96 Byzantia



96 Getafe



97 Gela



97 Galati



98 Nica



98 Filaga



99 Agna



99 Agliano



99 Dublina



99 Arago



100 Lorica



100 Matane



100 Dodona



101 Essa



101 Tonala



102 Galleno



102 Fossa



102 Solva



103 Altedo



103 Larru

FOLK

Cato



Zinn Optik antik
Antique pewter look
Aspect étain antique
Tinkleurig antiek

Calili



Zinn Optik antik
Antique pewter look
Aspect étain antique
Tinkleurig antiek

9 208 030 30

9 208 068 100

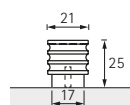
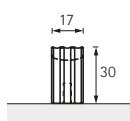
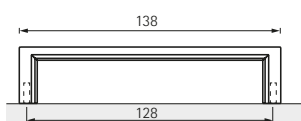

Ponzone



- 1 Zinn Optik antik
Antique pewter look
Aspect étain antique
Tinkleurig antiek



- 2 Bronze Optik antik
Antique bronze look
Aspect bronze antique
Bronskleurig antiek

Ponti



- 1 Zinn Optik antik
Antique pewter look
Aspect étain antique
Tinkleurig antiek



- 2 Bronze Optik antik
Antique bronze look
Aspect bronze antique
Bronskleurig antiek

1	9 206 136	50		
2	9 113 430	50		

1	9 206 134	200		
2	9 113 429	200		

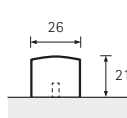
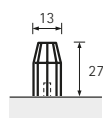
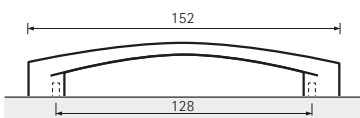

FOLK

Corduba



Zinn Optik
Pewter effect
Aspect étain
Tinkleurig

		☐
0 115 266	50	

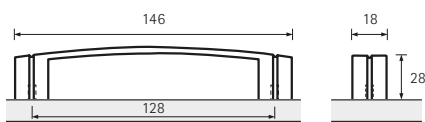

Vesontio



Zinn Optik
Pewter effect
Aspect étain
Tinkleurig

		☐
9 112 635	25	

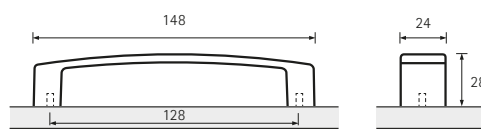

Ponoka



1 Verchromt glanz
Bright chrome plated
Chromé brillant
Verchromd glans

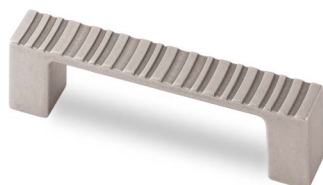

2 Zinn Optik
Pewter effect
Aspect étain
Tinkleurig

		☐
1 9 080 851	50	
2 9 080 850	50	

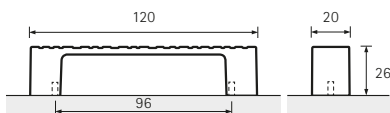

Oka



1 Verchromt glanz
Bright chrome plated
Chromé brillant
Verchromd glans



2 Zinn Optik
Pewter effect
Aspect étain
Tinkleurig

		☐
1 9 080 852	100	
2 9 080 853	100	

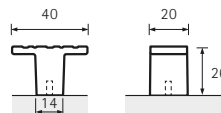

Luro



1 Zinn Optik
Pewter effect
Aspect étain
Tinkleurig



2 Messing Optik antik
Antique brass look
Aspect laiton antique
Messingkleurig antiek

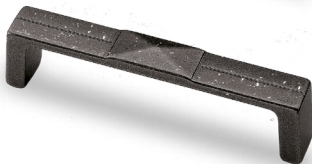

3 Schwarz matt Vintage
Matt black vintage
Noir mat vintage
Zwart mat vintage

			☐
1	9 112 601	50	
2	9 206 237	50	
3	9 206 239	50	



Tarraco



1 Zinn Optik
Pewter effect
Aspect étain
Tinkleurig



2 Messing Optik antik
Antique brass look
Aspect laiton antique
Messingkleurig antiek



3 Schwarz matt Vintage
Matt black vintage
Noir mat vintage
Zwart mat vintage

			☐
1	9 112 607	40	
2	9 206 137	40	
3	9 206 138	40	

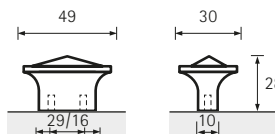

Pomezia



Messing Optik antik
Antique brass look
Aspect laiton antique
Messingkleurig antiek

☐	☐	☐	☐
96	104	9 266 566	25
128	136	9 266 567	20
160	168	9 266 568	25

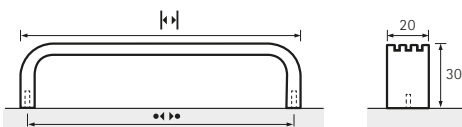

Potovio



Zinn Optik
Pewter effect
Aspect étain
Tinkleurig

		☐
9 112 650	50	

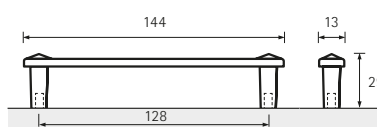

FOLK

Barcino



1 Zinn Optik
Pewter effect
Aspect étain
Tinkleurig



2 Messing Optik antik
Antique brass look
Aspect laiton antique
Messingkleurig antiek



3 Schwarz matt Vintage
Matt black vintage
Noir mat vintage
Zwart mat vintage

	9 112 652	100
1	9 112 652	100
2	9 206 130	100
3	9 206 131	100

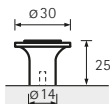

Bracara



1 Zinn Optik
Pewter effect
Aspect étain
Tinkleurig



2 Messing Optik antik
Antique brass look
Aspect laiton antique
Messingkleurig antiek



3 Schwarz matt Vintage
Matt black vintage
Noir mat vintage
Zwart mat vintage

	96	114	32	9 112 631	50
1	128	150	33	9 112 600	50
2	96	114	32	9 206 126	50
2	128	150	33	9 206 127	50
3	96	114	32	9 206 128	50
3	128	150	33	9 206 129	50

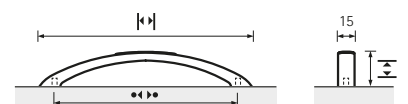

Olisipo



1 Zinn Optik
Pewter effect
Aspect étain
Tinkleurig



2 Zinn Optik
Pewter look
Aspect étain
Tinkleurig

	0 115 374	25
1	0 115 374	25
2	9 112 632	50

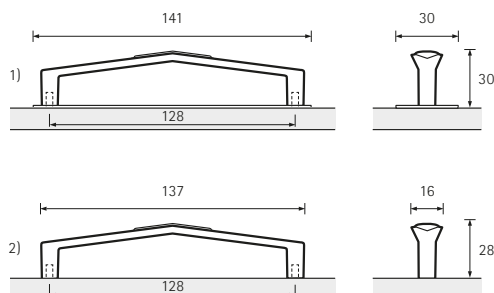

Arezzo

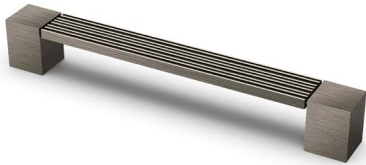

Zinn Optik
Pewter effect
Aspect étain
Tinkleurig

Topeka



Schwarz matt
Matt black
Noir mat
Zwart mat

			☐
9 264 060	25		

•••	☐		☐
96	160	9 266 419	25
128	192	9 266 420	25
160	224	9 270 230	25

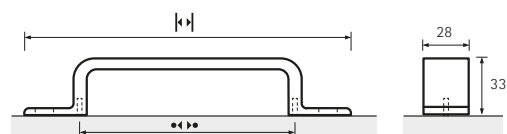
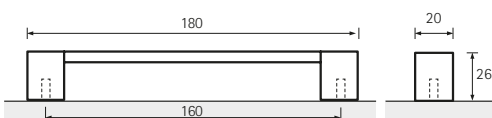

FOLK

Siradia



1 Zinn Optik antik
Antique pewter look
Aspect étain antique
Tinkleurig antiek



2 Messing Optik antik
Antique brass look
Aspect laiton antique
Messingleurig antiek

			☐
1	9 208 026	25	
2	9 208 027	25	

Sertao



1 Zinn Optik antik
Antique pewter look
Aspect étain antique
Tinkleurig antiek



2 Messing Optik antik
Antique brass look
Aspect laiton antique
Messingleurig antiek

			☐
1	9 208 064	40	
2	9 208 065	40	

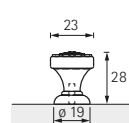
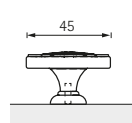
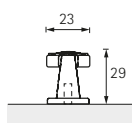
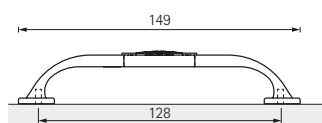

Haida



- 1 Edelstahl Optik gebürstet
Brushed stainless steel look
Aspect inox brossé
Roestvrij staal finish geborsteld



- 2 Messing Optik antik gebürstet
Brushed antique brass look
Aspect laiton antique brossé
Messingkleurig antiek geborsteld

1	9 113 225	50
2	9 113 227	50

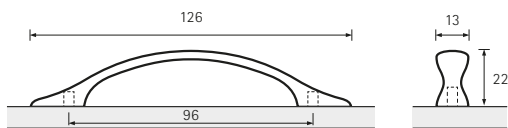

Terranda



- Edelstahl Optik gebürstet
Brushed stainless steel look
Aspect inox brossé
Roestvrij staal finish geborsteld

96	112	24	9 113 327	50
128	146	28	9 113 292	40

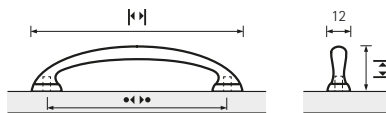

Gissi



- Zinn Optik
Pewter effect
Aspect étain
Tinkleurig

9 112 651	100
-----------	-----

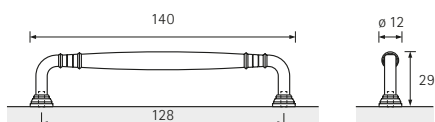

Osimo



- 1 Zinn Optik antik
Antique pewter look
Aspect étain antique
Tinkleurig antiek



- 2 Messing Optik antik
Antique brass look
Aspect laiton antique
Messingkleurig antiek

1	9 113 445	50
2	9 113 444	50

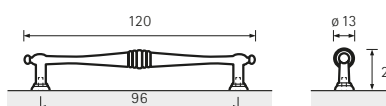

FOLK

Malaca



1 Zinn Optik
Pewter effect
Aspect étain
Tinkleurig



2 Messing Optik antik
Antique brass look
Aspect laiton antique
Messingleurig antiek

			☐
1	9 070 943	50	
2	9 070 945	50	

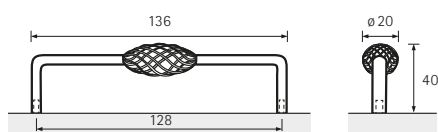

Valentia



1 Zinn Optik
Pewter effect
Aspect étain
Tinkleurig



2 Messing Optik antik
Antique brass look
Aspect laiton antique
Messingleurig antiek

			☐
1	9 070 510	75	
2	9 070 513	75	

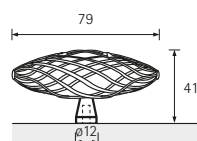

Egara



- 1 Zinn Optik gebürstet
Brushed pewter effect
Aspect étain brossé
Tinkleurig geborsteld



- 2 Messing Optik antik gebürstet
Brushed antique brass look
Aspect laiton antique brossé
Messingkleurig antiek geborsteld



- 3 Bronze Optik antik gebürstet
Brushed antique bronze look
Aspect bronze antique brossé
Bronskleurig antiek geborsteld

1	9 071 720	20	
2	9 071 719	20	
3	9 071 718	20	

Bruxella



- Edelstahl Optik gebürstet
Brushed stainless steel look
Aspect inox brossé
Roestvrij staal finish geborsteld

	9 112 619	50	

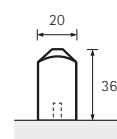
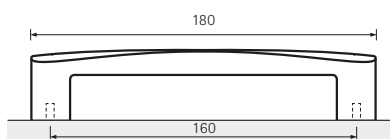
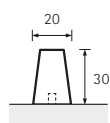
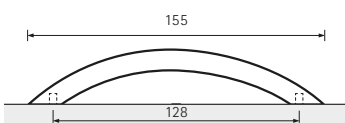

FOLK

Salacia



1 Silber Optik antik
Antique silver look
Aspect argent antique
Zilverkleurig antiek



2 Zinn Optik
Pewter effect
Aspect étain
Tinkleurig

	•••	K ₁	K ₂		□
1	128	151	23	9 112 594	50
2	128	151	23	9 112 591	50

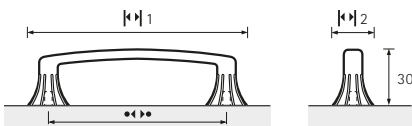

Eburaco



1 Silber Optik antik
Antique silver look
Aspect argent antique
Zilverkleurig antiek



2 Zinn Optik
Pewter effect
Aspect étain
Tinkleurig

		□
1	9 112 654	100
2	9 112 653	100

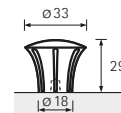

Savelli



Edelstahl Optik gebürstet
Brushed stainless steel look
Aspect inox brossé
Roestvrij staal finish geborsteld

	□
9 113 483	50

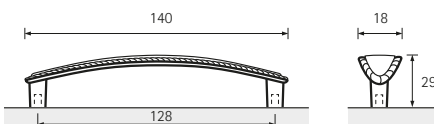

Salemi



Edelstahl Optik gebürstet
Brushed stainless steel look
Aspect inox brossé
Roestvrij staal finish geborsteld

	□
9 113 368	75

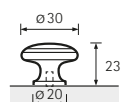

Alberta



- 1 Edelstahl Optik gebürstet
Brushed stainless steel look
Aspect inox brossé
Roestvrij staal finish geborstelt



- 2 Messing Optik antik
Antique brass look
Aspect laiton antique
Messingkleurig antiek



- 3 Zinn Optik antik
Antique pewter look
Aspect étain antique
Tinkleurig antiek

Ogulin



- Zinn Optik antik
Antique pewter look
Aspect étain antique
Tinkleurig antiek

			☐
1	9 113 181	50	
2	9 113 179	50	
3	9 113 180	50	

•••			☐
128	152	9 266 562	30
160	184	9 266 563	20
192	216	9 266 564	20
224	248	9 266 565	20

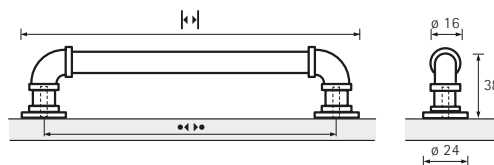
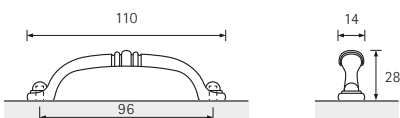

FOLK

Meduno



Zinn Optik
Pewter effect
Aspect étain
Tinkleurig

		☐
9 112 662	50	

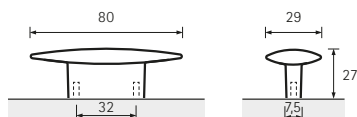

Emo



Edelstahl Optik gebürstet
Brushed stainless steel look
Aspect inox brossé
Roestvrij staal finish geborsteld

		☐
1 170 173	40	

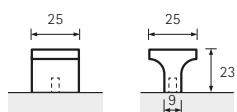

Flavia



1 Vernickelt matt
Matt nickel plated
Nickelé mat
Vernikkeld mat



2 Zinn Optik
Pewter effect
Aspect étain
Tinkleurig

		☐
1	0 115 293	50
2	0 115 292	50

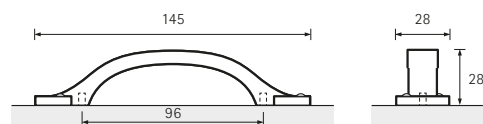

Bevipo



Zinn Optik
Pewter effect
Aspect étain
Tinkleurig

Dipo



Zinn Optik
Pewter effect
Aspect étain
Tinkleurig

0 115 263 50

0 115 264 100

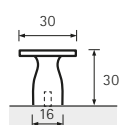
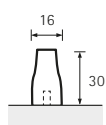
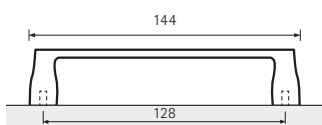

FOLK

Byzantia



- 1 Echtleder dunkelbraun /
Edelstahl Optik gebürstet
Dark brown leather /
Brushed stainless steel look
Cuir à dessins brun foncé /
Aspect inox brossé
Donkerbruin leer /
Roestvrij staal finish geborsteld



- 2 Echtleder dunkelbraun gemustert /
Edelstahl Optik gebürstet
Patterned dark brown leather /
Brushed stainless steel look
Cuir brun foncé à dessins /
Aspect inox brossé
Donkerbruin leer dessin /
Roestvrij staal finish geborsteld



- 3 Echtleder schwarz /
Edelstahl Optik gebürstet
Black leather /
Brushed stainless steel look
Cuir noir / Aspect inox brossé
Zwart leer / Roestvrij staal finish
geborsteld

Getafe



- 1 Echtleder hellbraun /
Edelstahl gebürstet
Light brown leather /
Brushed stainless steel
Cuir brun clair / Inox brossé
Lichtbruin leer /
Roestvrij staal geborsteld



- 2 Echtleder dunkelbraun /
Edelstahl gebürstet
Dark brown leather /
Brushed stainless steel
Cuir brun foncé / Inox brossé
Donkerbruin leer /
Roestvrij staal geborsteld



- 3 Echtleder schwarz / Edelstahl gebürstet
Black leather / Brushed stainless steel
Cuir noir / Inox brossé
Zwart leer / Roestvrij staal geborsteld

	•••	•		□
1	128	188	9 070 143	40
1	160	220	9 070 148	40
2	128	188	9 070 144	40
2	160	220	9 070 149	40
3	128	188	9 070 142	40
3	160	220	9 070 147	40

	•••	•		□
1	160	170	9 131 321	50
1	224	234	9 131 324	50
2	160	170	9 131 320	50
2	224	234	9 131 323	50
3	160	170	9 131 319	50
3	224	234	9 131 322	50

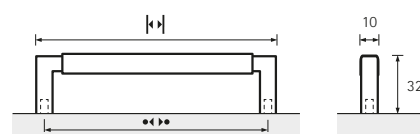
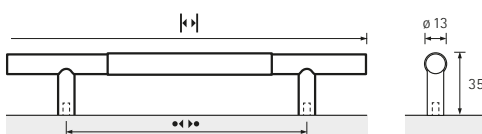

Gela



- 1 Echtleder hellbraun
Light brown leather
Cuir brun clair
Lichtbruin leer



- 2 Echtleder dunkelbraun
Dark brown leather
Cuir brun foncé
Donkerbruin leer



- 3 Echtleder schwarz
Black leather
Cuir noir
Zwart leer

Befestigungssockel siehe Seite 112
For attachment base, see page 112
Socle de fixation voir page 112
Voor bevestigingsvoet zie pagina 112

1	9 113 645	100	□
2	9 113 646	100	
3	9 113 647	100	

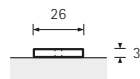
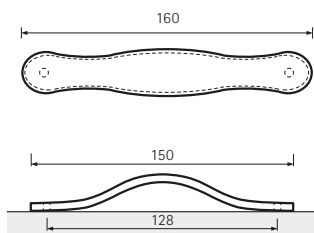

Galati



- 1 Echtleder hellbraun
Light brown leather
Cuir brun clair
Lichtbruin leer



- 2 Echtleder dunkelbraun
Dark brown leather
Cuir brun foncé
Donkerbruin leer



- 3 Echtleder schwarz
Black leather
Cuir noir
Zwart leer

Befestigungssockel siehe Seite 112
For attachment base, see page 112
Socle de fixation voir page 112
Voor bevestigingsvoet zie pagina 112

1	9 113 648	200	□
2	9 113 649	200	
3	9 113 650	200	

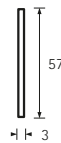
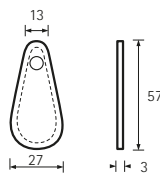

FOLK

Nica



- 1 Echtleder hellbraun
Light brown leather
Cuir brun clair
Lichtbruin leer



- 2 Echtleder dunkelbraun
Dark brown leather
Cuir brun foncé
Donkerbruin leer



- 3 Echtleder schwarz
Black leather
Cuir noir
Zwart leer

Befestigungsschraube siehe Seite 112
For fixing screw, see page 112
Vis de fixation, voir page 112
Voor bevestigingsschroef zie pagina 112

	•••	k ₁	k ₂	□
1	64	94	126	9 071 842 100
1	96	126	158	9 071 839 100
1	128	158	190	9 071 836 100
2	64	94	126	9 071 843 100
2	96	123	158	9 071 840 100
2	128	158	190	9 071 837 100
3	64	94	126	9 071 844 100
3	96	126	158	9 071 841 100
3	128	158	190	9 071 838 100

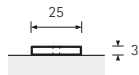
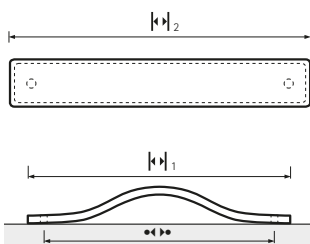

Filaga



- 1 Echtleder hellbraun / Vernickelt matt
Light brown leather / Matt nickel plated
Cuir brun clair / Nickelé mat
Lichtbruin leer / Vernikkeld mat



- 2 Echtleder dunkelbraun / Vernickelt matt
Dark brown leather / Matt nickel plated
Cuir brun foncé / Nickelé mat
Donkerbruin leer / Vernikkeld mat



- 3 Echtleder schwarz / Vernickelt matt
Black leather / Matt nickel plated
Cuir noir / Nickelé mat
Zwart leer / Vernikkeld mat

	□
1	9 113 691 175
2	9 113 594 175
3	9 113 694 175

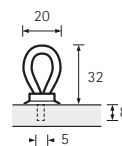

Agna



- 1 Echtleder dunkelbraun /
Edelstahl Optik gebürstet
Dark brown leather /
Brushed stainless steel look
Cuir brun foncé / Aspect inox brossé
Donkerbruin leer /
Roestvrij staal finish geborsteld

			☐
9 113 451	50		

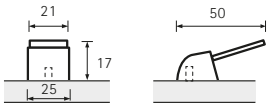

Agliano



- 1 Echtleder dunkelbraun /
Edelstahl Optik gebürstet
Dark brown leather /
Brushed stainless steel look
Cuir brun foncé / Aspect inox brossé
Donkerbruin leer /
Roestvrij staal finish geborsteld

			☐
96	110	9 113 453	30
128	142	9 113 454	30

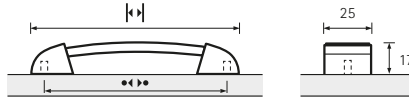

Dublina



- 1 Echtleder dunkelbraun
Dark brown leather
Cuir brun foncé
Donkerbruin leer



- 2 Echtleder schwarz
Black leather
Cuir noir
Zwart leer

			☐
1	9 113 509	20	
2	9 113 508	20	

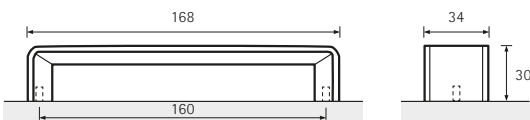

Arago



- Echtleder schwarzgrau / Zinn Optik antik
Black grey leather /
Antique pewter look
Cuir gris noir / Aspect étain antique
Zwartgrijs leer / Tinkleurig antiek

			☐
		9 207 452	12

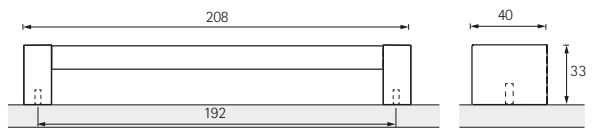

FOLK

Lorica



Zinn Optik
Pewter effect
Aspect étain
Tinkleurig

		☐
9 112 655	50	

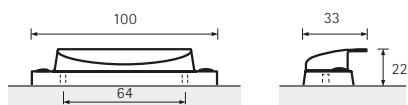

Matane



1 Edelmetall Optik gebürstet
Brushed stainless steel look
Aspect inox brossé
Roestvrij staal finish geborsteld



2 Schwarz matt
Matt black
Noir mat
Zwart mat

		☐
1	9 113 228	50
2	9 260 744	50

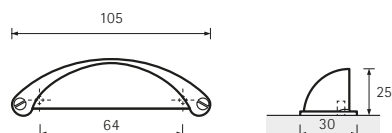

Dodona



Edelmetall gebürstet
Brushed stainless steel
Inox brossé
Roestvrij staal geborsteld

		☐
9 070 693	50	

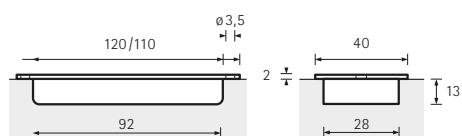

Essa



1 Zinn Optik
Pewter effect
Aspect étain
Tinkleurig



2 Messing Optik antik
Antique brass look
Aspect laiton antique
Messingkleurig antiek



3 Kupfer Optik antik
Antique copper look
Aspect cuivre antique
Koperkleurig antiek



4 Zinn Optik antik
Antique pewter look
Aspect étain antique
Tinkleurig antiek

			☐
1	9 113 222	50	
2	9 113 221	50	
3	9 113 223	50	
4	9 113 220	50	

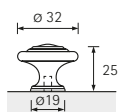

Tonala



Schwarz matt
Matt black
Noir mat
Zwart mat

			☐
	9 266 561	50	

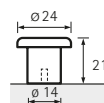

FOLK

Galleno



- 1 Verchromt glanz
Bright chrome plated
Chromé brillant
Verchroomd glans



- 2 Vernickelt matt
Matt nickel plated
Nickelé mat
Vernikkeld mat



- 3 Edelfstahl Optik gebürstet
Brushed stainless steel look
Aspect inox brossé
Roestvrij staal finish geborsteld

1	9 206 133	100	
2	9 112 599	100	
3	9 206 132	100	

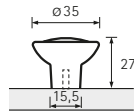

Fossa



- Zinn Optik
Pewter effect
Aspect étain
Tinkleurig

	9 112 646	100	

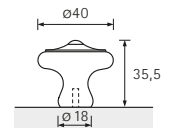

Solva



- 1 Messing Optik glanz
Bright brass look
Aspect laiton brillant
Messingkleurig glanzend



- 2 Messing Optik antik
Antique brass look
Aspect laiton antique
Messingkleurig antiek

1	9 070 575	75	
2	9 113 286	75	

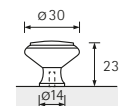

Altedo



- 1 Edelstahl Optik gebürstet
Brushed stainless steel look
Aspect inox brossé
Roestvrij staal finish geborsteld



- 2 Zinn Optik antik
Antique pewter look
Aspect étain antique
Tinkleurig antiek



- 3 Schwarz matt
Matt black
Noir mat
Zwart mat

Larru



- Zinn Optik gebürstet
Brushed pewter effect
Aspect étain brossé
Tinkleurig geborsteld

		☐
1	9 113 293	50
2	9 204 153	50
3	9 265 886	50

	☐
9 113 659	75

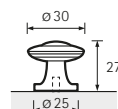
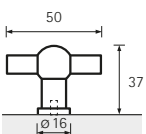

TOUCH-IN

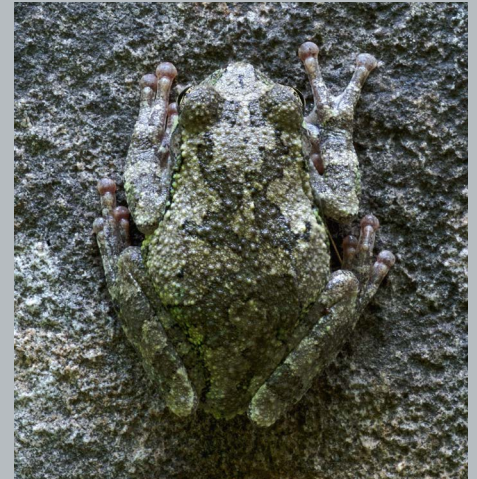

Schafft Gestaltungsfreiheit in Form und Farbe
Creates design flexibility in shape and colour
Pour agir en toute liberté au niveau de la forme et de la couleur
Biedt vrijheid bij de vormgeving, zowel qua vorm als kleur

Das besondere Grifferlebnis

In nahezu grifflos erscheinenden Fronten verbirgt sich, so einfach wie raffiniert, die Grifffunktion von Touch-in. Mit den modularen oder einbaufertigen Griffen können Sie vielfältige Varianten realisieren – designgleich zur Front oder kontrastierend. Touch-in-Griffe können vom Verarbeiter in Frontfarbe lackiert oder mit einem Wunschdekor beschichtet werden.

The unique handle experience

Ingeniously yet with amazing simplicity, the Touch-in handle function is concealed in front panels that almost seem to be handleless. The modular or ready to install handles give you a wide choice of design options – matching the front panel or contrasting with it. Touch-in handles can be lacquered by the fabricator in front panel colour or finished in any chosen decor.

Une expérience particulière avec les poignées

La fonctionnalité de la poignée Touch-in est dissimulée simplement et subtilement dans les façades paraissant presque dépourvues de poignées. Les poignées modulaires ou prêtes à être posées vous permettent de concevoir d'innombrables variantes – soit en parfaite harmonie avec la façade, soit en contraste. Les professionnels du meuble peuvent laquer les poignées Touch-in dans la couleur de la façade ou les revêtir d'un décor personnalisé.

De bijzondere greepbeleving

In vrijwel greeploos ogende fronten gaat, zowel eenvoudig als geraffineerd, de greepfunctie van Touch-in schuil. Met de modulaire of kant-en-klare grepen kunt u veelzijdig variëren – in hetzelfde design als het front of contrasterend. Touch-in grepen kunnen in de frontkleur worden gelakt of met een decor naar eigen wens worden bekleed.

Touch-in einbaufertig
ready to install
prêt à être incorporé
kant-en-klaar



1 Verchromt glanz
Bright chrome plated
Chromé brillant
Verchromd glans



2 Edelstahl Optik gebürstet
Brushed stainless-steel look
Aspect inox brossé
Roestvrij staal finish geborsteld



1 Verchromt glanz
Bright chrome plated
Chromé brillant
Verchromd glans



2 Edelstahl Optik gebürstet
Brushed stainless-steel look
Aspect inox brossé
Roestvrij staal finish geborsteld

1	9 086 690	25
2	9 086 689	25

1	9 086 688	25
2	9 086 687	25

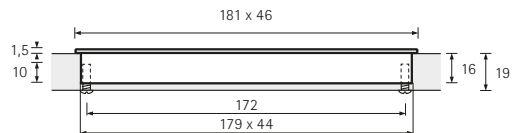
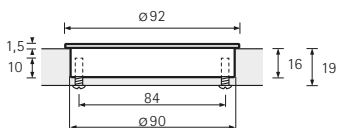

TOUCH-IN

Touch-in modular modular modulaire modulair



- 1 Verchromt glanz
Bright chrome plated
Chromé brillant
Verchromd glans



- 2 Edeldahl Optik gebürstet
Brushed stainless-steel look
Aspect inox brossé
Roestvrij staal finish geborsteld



- 1 Verchromt glanz
Bright chrome plated
Chromé brillant
Verchromd glans



- 2 Edeldahl Optik gebürstet
Brushed stainless-steel look
Aspect inox brossé
Roestvrij staal finish geborsteld

1	9 086 694	25	
2	9 086 693	25	

1	9 086 692	25	
2	9 086 691	25	

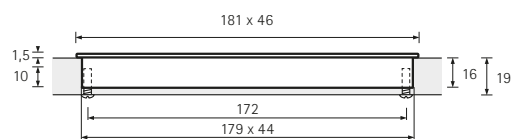
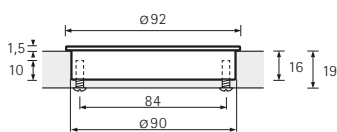

Touch-in modular
 modular
 modulaire
 modulair

Dekorelemente (ABS) zum Selbstlackieren
 Trim panels (ABS) for laquer coating
 Élément décoratif (ABS) à laquer soi-même
 Decoratief element (ABS) om zelf te lakken



- 1 Kunststoff unbeschichtet
 Uncoated plastic
 Plastique non revêtu
 Kunststof ongecoat



- 1 Kunststoff unbeschichtet
 Uncoated plastic
 Plastique non revêtu
 Kunststof ongecoat

Dekorelemente für den Einsatz von Schichtstoff
 Trim panels for applying laminate
 Éléments pour la mise en œuvre de stratifié
 Decoratief element voor het gebruik van eigen materiaal



- 2 Verchromt glanz
 Bright chrome plated
 Chromé brillant
 Verchromd glans



- 2 Verchromt glanz
 Bright chrome plated
 Chromé brillant
 Verchromd glans



- 3 Edelstahl Optik
 Stainless steel look
 Aspect inox
 Roestvrij staal finish



- 3 Edelstahl Optik
 Stainless steel look
 Aspect inox
 Roestvrij staal finish

1	9 086 698	25
2	9 086 702	25
3	9 086 701	25

1	9 086 695	25
2	9 086 697	25
3	9 086 696	25

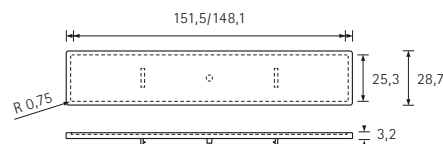
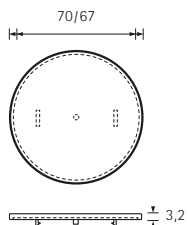

TOUCH-IN

Touch-in modular modular modulaire modulair

Dekorelemente (ABS) zum Selbstlackieren
Trim panels (ABS) for laquer coating
Élément décoratif (ABS) à laquer soi-même
Decoratief element (ABS) om zelf te lakken

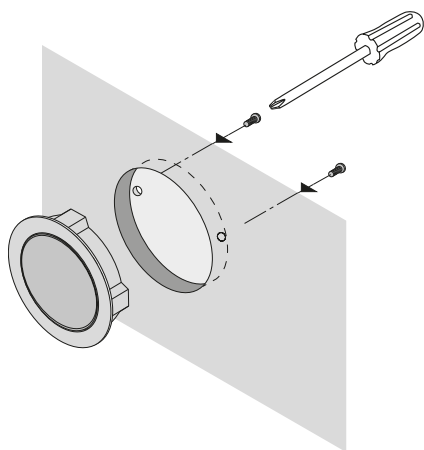
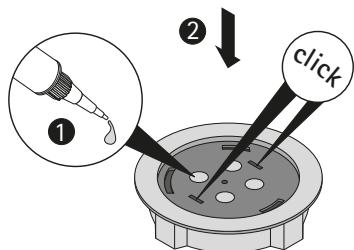
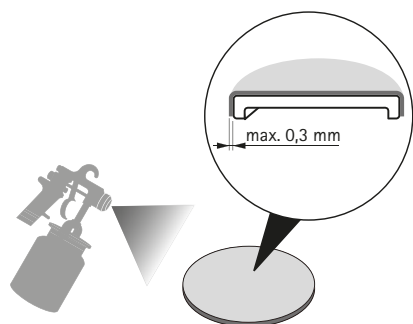

Dekorelemente für den Einsatz von Schichtstoff
Trim panels for applying laminate
Éléments pour la mise en œuvre de stratifié
Decoratief element voor het gebruik van eigen materiaal

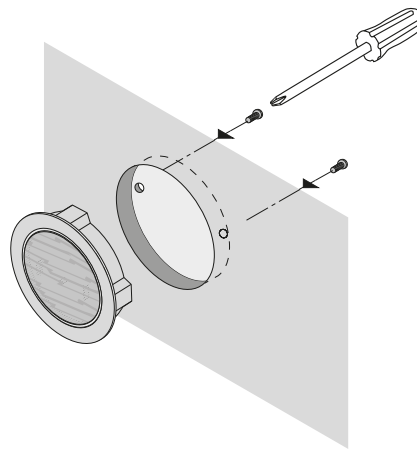
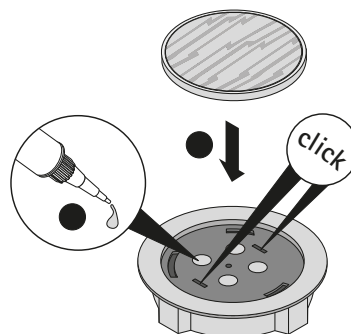
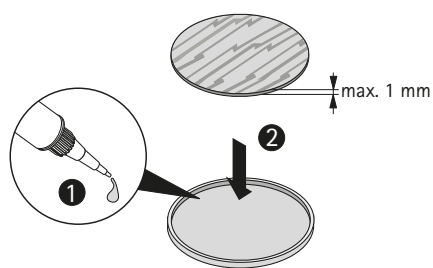

empfohlener Klebstoff: 2K SE Polymer, z. B. JOWAT 690.00
recommended adhesive: 2-comp. SE polymer, e.g. JOWAT 690.00
colle recommandée: polymère sylile époxy bicomposant, par exemple JOWAT 690.00
Aanbevolen lijm: 2K SE Polymer, b.v. JOWAT 690.00

Dekorelemente (ABS) zum Selbstlackieren
 Trim panels (ABS) for laquer coating
 Élement décoratif (ABS) à laquer soi-même
 Decoratief element (ABS) om zelf te lakken

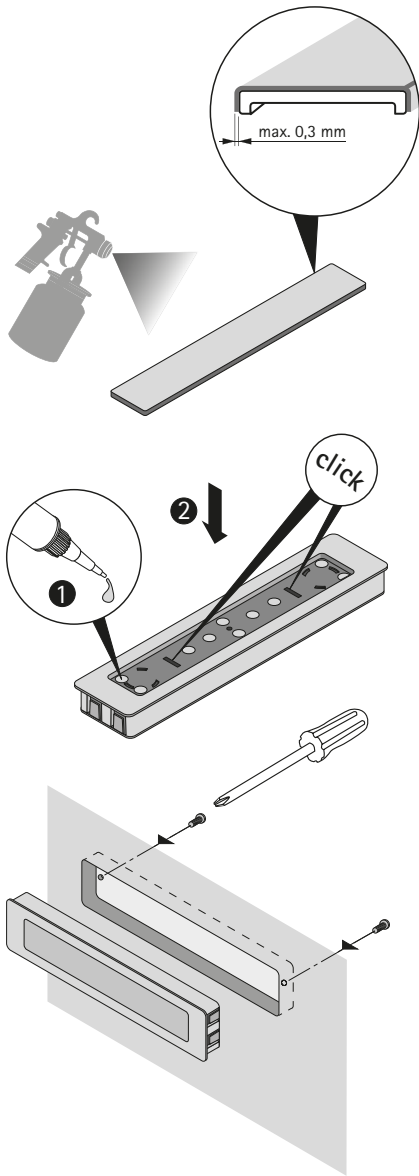

Dekorelemente für den Einsatz von Schichtstoff
 Trim panels for applying laminate
 Éléments pour la mise en œuvre de stratifié
 Decoratief element voor het gebruik van eigen materiaal

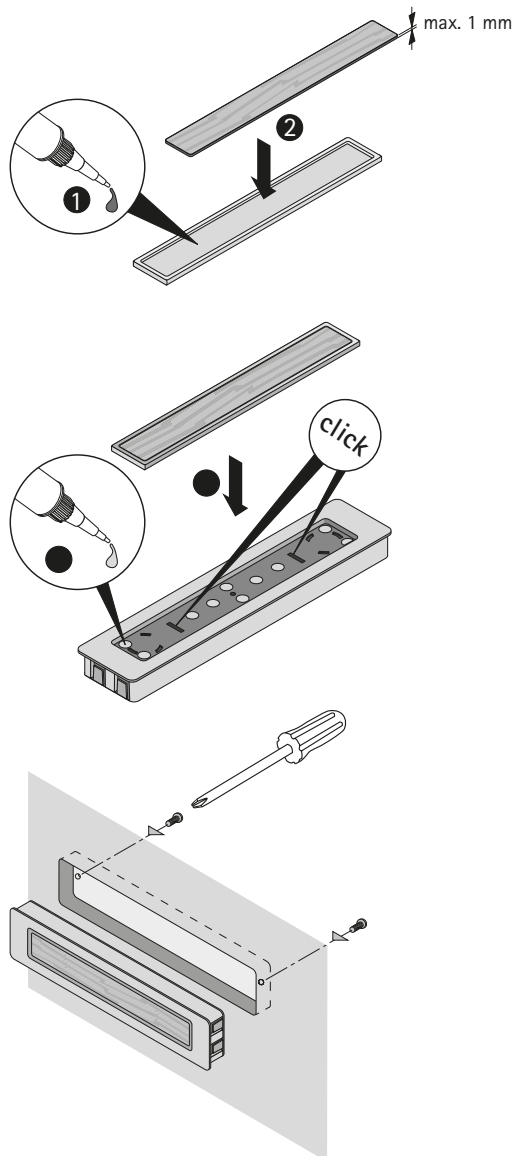

SERVICE

Hettich Service:
Kompetenz im Netz

Hettich Service:
Expertise on the web

Hettich Service:
la compétence sur Internet

Hettich service:
online competentie



Neue Möbelideen wirtschaftlich verwirklichen und das Bewährte stets verbessern!

Hettich unterstützt Sie online von der Ideenfindung über die konkrete Korpusplanung und Wahl der richtigen Beschläge bis hin zur effizienten Umsetzung.

Auf www.hettich.com finden Sie jede Menge Inspiration. Die passenden Beschläge dafür sind im Onlinekatalog mit erstem Produktüberblick bis zur Detailinformation schnell gefunden.

Für die exakte und einfache Planung mit Hettich Beschlägen stehen Ihnen die Korpusplanung mit HettichPlan, die Design Gallery mit konkreten Umsetzungslösungen sowie die Hettich CAD Beschlagbibliothek zur Verfügung. Der Hettich Technical Assistant hilft Ihnen bei der Montage und Einstellung der Hettich Produkte.

Realise new furniture ideas cost effectively and constantly improve the tried and tested!

Hettich assists you online with finding ideas, planning specific cabinet bodies, selecting the right fittings and efficient realisation.

You will find a wealth of inspiration at www.hettich.com. The right fittings are quickly found in the online catalogue with everything from an initial overview of products to detailed information.

You can use various tools for accurately and easily planning furniture with Hettich fittings: cabinet body planning with HettichPlan, the Design Gallery with specific solutions for realising furniture as well as the Hettich CAD fittings library. The Hettich Technical Assistant helps you with assembling and adjusting Hettich products.



Hettich App:

Unsere App erhalten Sie im jeweiligen Online Store

Hettich app:

Our app is available from the relevant online store

Appli Hettich :

Vous obtiendrez notre appli dans la boutique en ligne respective

Hettich app:

Onze app vindt u in de betreffende online store



Das gesamte Produktprogramm, weitere technische Details und zusätzlich benötigte Informationen finden sie im Hettich eShop.

You will find the entire product range, further technical details and any additional information you require in the Hettich eShop.

Vous trouverez toutes nos gammes de produits, de plus amples informations techniques et toutes les informations supplémentaires dont vous avez besoin dans le Hettich eShop.

Het volledige productassortiment, evenals technische en andere benodigde informatie vindt u in de Hettich eShop.



Pour réaliser de nouvelles idées de meubles de manière économique et pour améliorer constamment ce qui a déjà fait ses preuves !

Hettich vous apporte en ligne l'aide dont vous avez besoin non seulement pour trouver des idées, pour planifier concrètement un corps de meuble, pour choisir les ferrures adaptées, mais également pour réaliser l'ensemble de manière efficace.

Le site Internet www.hettich.com est une riche source d'inspiration. Vous trouverez rapidement les ferrures adaptées à tous vos projets de meubles dans le catalogue en ligne. Vous pourrez y consulter tout d'abord l'aperçu du produit puis toutes les informations détaillées le concernant.

Vous disposez de nombreux eTools astucieux pour concevoir facilement et avec précision vos meubles avec les ferrures Hettich : HettichPlan pour planifier le corps de meuble, la galerie des designs regroupant des solutions concrètes de mise en œuvre de nos produits ainsi que la bibliothèque de nos ferrures Hettich CAD.

Le Hettich Technical Assistant vous aide lors du montage et du réglage des produits Hettich.

Nieuwe meubelideeën op economische wijze omzetten en beproefde elementen continu verbeteren!

Hettich helpt u online bij het vinden van ideeën en de concrete kastplanning tot aan de keuze van het passende beslag en de efficiënte realisatie.

Op www.hettich.com vindt u een heleboel inspiratie. Het passende beslag hiervoor is snel gevonden in de online catalogus, van een eerste productoverzicht tot gedetailleerde informatie.

Voor de exacte en eenvoudige planning met Hettich beslag kan worden gekozen uit de kastplanning met Hettich Plan, de Design Gallery met concrete implementatie-oplossingen en de Hettich CAD beslagbibliotheek.

De Hettich Technical Assistant helpt u bij het monteren en instellen van de Hettich producten.

SERVICE

Befestigungsmaterial Fixing accessories Accessoires de fixation Bevestigingsmateriaal

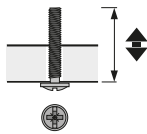

Griff-Befestigungsschrauben
mit Kreuz-Doppelschlitze
Stahl verzinkt

Handle fixing screws cross-slotted
Galvanized steel

Vis de fixation de poignées
à fente cruciforme
Acier zingué

Greepbevestigingsschroeven
met dubbele kruisgleuf
Verzinkt staal

l		
M 4 x 12	0 071 544	50
M 4 x 14	0 071 545	50
M 4 x 16	0 071 546	50
M 4 x 18	0 071 547	50
M 4 x 20	0 071 548	50
M 4 x 22	0 071 549	50
M 4 x 24	0 071 555	50
M 4 x 26	0 071 556	50
M 4 x 28	0 071 557	50

l		
M 4 x 30	0 071 558	50
M 4 x 32	0 071 559	50
M 4 x 34	0 071 560	50
M 4 x 36	0 071 561	50
M 4 x 38	0 071 562	50
M 4 x 40	0 071 563	50
M 4 x 42	0 071 855	50
M 4 x 45	0 071 856	50

Universal Griff-Befestigungsschraube
M4 x 45 mm mit Kreuz-Doppelschlitze
kürzbar auf 40, 35, 30, 25 oder 20 mm
Stahl verzinkt

Universal handle cross-slotted fixing
screw M4 x 45 mm, can be shortened to
40, 35, 30, 25 or 20 mm
Galvanized steel

Vis universelle de fixation de poignée
M4 x 45 mm à fente cruciforme
réductible à 40, 35, 30, 25 ou 20 mm
Acier zingué

Universele greepbevestigingsschroef
M4 x 45 mm met dubbele kruisgleuf,
inkortbaar tot 40, 35, 30, 25 en 20 mm
Verzinkt staal



	9 212 860	100



1 Aluminium Optik
Aluminium look
Aspect aluminium
Aluminiumkleurig

Befestigungssockel mit
M4 Gewinde für Ledergriffe
Gela und Galati
Zink



2 Verchromt glanz
Bright chrome plated
Chromé brillant
Glanzend verchromd

Attachment base with M4 thread
for leather handles
Gela and Galati
Zink



3 Vernickelt matt Optik
Matt nickel plated look
Aspect nickelé mat
Vernikkeld mat

Socle de fixation avec filetage M4 **
pour poignée en cuir
Gela et Galati
Zink



4 Bronze Optik antik
Antique bronze look
Aspect bronze antique
Bronskleurig antiek

Bevestigingsvoet met M4
schroefdraad voor leren grepen
Gela en Galati
Zink

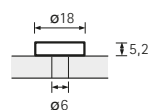

1	9 113 651	200
2	9 113 652	200
3	9 113 653	200
4	9 113 654	200



Spezialschraube für Ledergriff Nica
für Bohrung 5 mm
mit PZ-Kreuzschlitze ø 6,3 x 14 mm
Stahl verzinkt

Special screw for Nica leather handle
for 5 mm hole
with Pozidrive cross head ø 6,3 x 14 mm
Galvanized steel

Vis spéciale pour poignée en cuir Nica
pour perçage 5 mm
avec empreinte cruciforme PZ ø 6,3 x 14 mm
Acier zingué

Speciale schroef voor leren greep Nica
voor boring 5 mm
met PZ-kruisgleuf ø 6,3 x 14 mm
Verzinkt staal

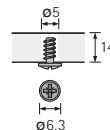

	0 046 700	200

Distanzhülsen für Glastüren
Spacer sleeve for glass doors
Entretoise pour portes en verre
Afstandshuls voor glasdeuren



Distanzhülse zur Griffbefestigung an Glastüren
 Kunststoff
 Spacer sleeve for fixing handle to glass doors
 Plastic
 Entretoise pour vis de maintien pour portes en verre
 Plastique
 Afstandshuls voor greepbevestiging bij glazen deuren
 Kunststof

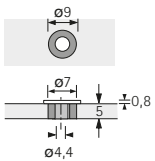

9 113 347	100
-----------	-----

Adapter für Faltschiebetüren
Handle adaptor for folding/sliding doors
Adaptateur de poignée pour portes pliantes coulissantes
Greepadapter voor vouw-/schuifdeuren



1 Verchromt matt
 Matt chrome plated
 Chromé mat
 Verchromd mat



2 Vernickelt matt
 Matt nickel plated
 Nickelé mat
 Vernikkeld mat



Kunststoff-Unterlegscheibe
 Plastic washer
 Rondelle en plastique
 Kunststof onderlegplaat

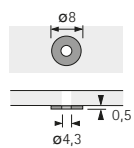

9 077 861	1000
-----------	------

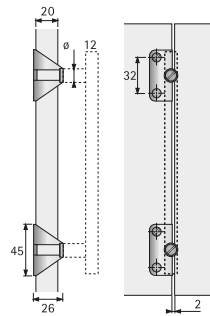

Einsetzbar für alle Grifflösungen bei einer maximalen Türdicke von 20 mm und einer Griff-Aufstandsfläche, mindestens $\varnothing 12$ mm.
 Can be used for all handle solutions on door thicknesses of up to 20 mm and a handle mounting surface greater than 12 mm in diameter.

Applicable pour toutes les solutions de portes d'une épaisseur maximale de 20 mm et une surface de maintien de poignée plus grande que $\varnothing 12$ mm.

Geschikt voor alle greepoplossingen met een max. deurdikte van 20mm en een bevestigingsoppervlakte diameter van 12mm.

1	0 115 365	100
2	0 115 366	100

SERVICE

Accura-Bohrlehren Accura drilling gauge Matrices de perçage Accura Accura-boormal

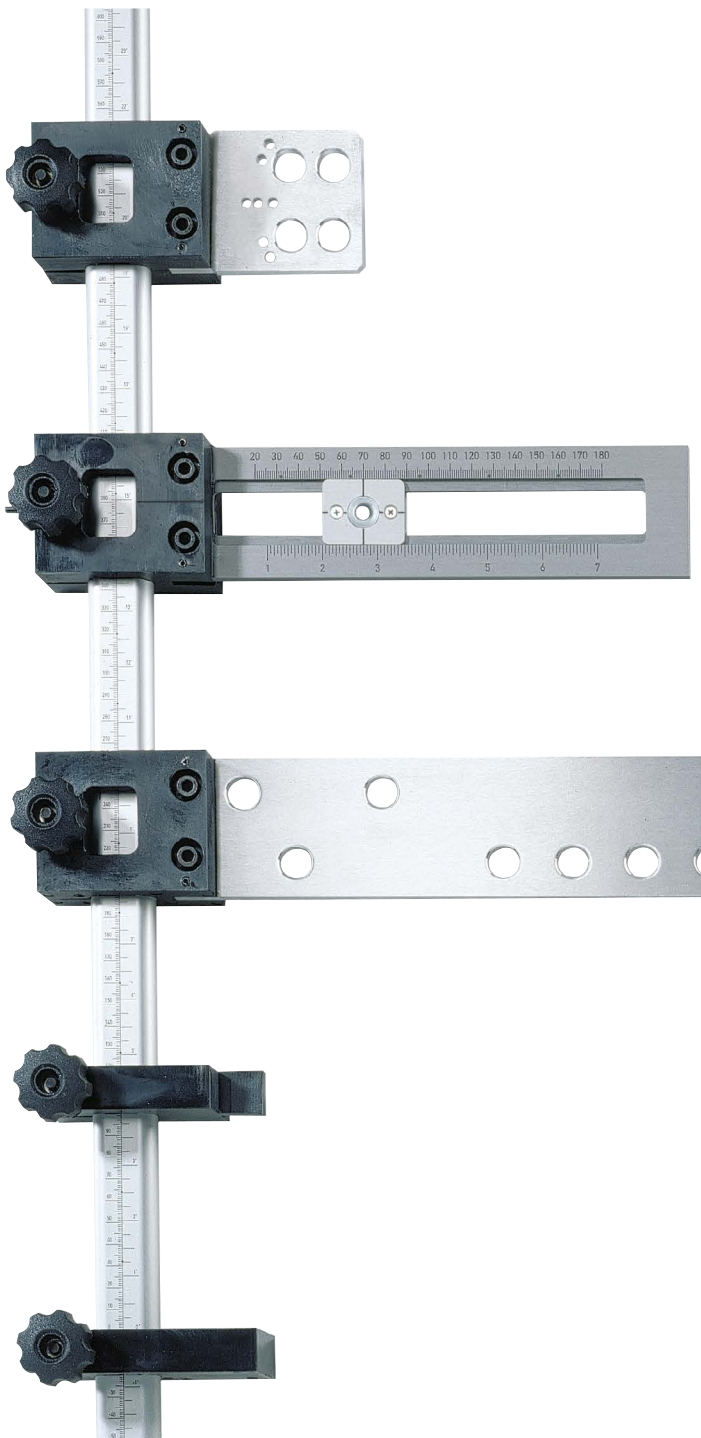

Accura – die rationelle, wirtschaftliche und fachgerechte Universal-Bohrlehre im Baukastensystem
Accura - the practical and efficient universal modular drilling jig for perfect work results
Accura - le gabarit universel, en système de construction par blocs, rationnel, économique et approprié
Accura - de praktische en efficiënte modulaire boormal voor de vakman

Accura-Bohrkörper für Griffe
Drilling jigs for handles
La plaque Accura pour poignées
Accura-boorlichaam voor grepen

Unterschiedliche Bohrkörper und Anschläge lassen sich auf der Accura-Schiene mit Mess-Skala in mm und Inch (Längen von 500 bis 2000 mm) beliebig positionieren.
Different drilling templates and stops can be positioned anywhere on the Accura rail with metric and imperial measurement scale (lengths from 500 to 2000 mm).
Différentes plaques de perçage et butées se laissent positionner au choix sur le gabarit Accura (longueur de 500 à 2000 mm) avec des graduations en mm et pouces.
Verschillende boorlichamen en aanslagen laten zich op de Accura rail met meetschaal in mm en Inch (lengte van 500 tot 2000 mm) willekeurig positioneren.

Markierungen für Bohrungen im 32er Raster.
Markings for drilling holes for the 32 mm hole spacing system.
Marquage pour rangée de trous en système 32.
Markering voor boringen in het systeem 32 raster.

Accura-Bohrkörper für Griffe
Accura drilling jigs for handles
La plaque Accura pour poignées
Accura-boorlichaam voor grepen

- Accura-Bohrlehre, Set für Griffe besteht aus:
- 2 Accura-Bohrkörper für Griffe
 - 2 Bohrplatten mit Führungshülse für 5 mm-HSS-Spiralbohrer
 - 1 Accura-Schiene mit Maß-Skala in mm und Inch, Länge 500mm
 - 1 verstellbarer Anschlag für Fronten
- ② Accura-Schiene mit Mess-Skala in mm und Inch, mit Markierungspunkten „Raster 32“
- ┆ 500 mm
 - ┆ 1000 mm
 - ┆ 1500 mm
 - ┆ 2000 mm
- ③ Accura-Bohrkörper für Griffe, inkl. Bohrplatte mit Führungshülse für 5 mm-HSS-Spiralbohrer Aluminium/Kunststoff
- ④ Ersatzschieber mit Bohrbuchse für Accura-Bohrkörper für Griffe
- ⑤ Spiralbohrer 5 mm
- ⑥ Verstellbarer Anschlag für Fronten und einzelne (zerlegte) Korpusseiten, Kunststoff

- Accura drilling gauge, kit for handles contains:
- 2 Accura drill templates for handles
 - 2 drill plates with guide sleeve for 5 mm high-powered high-speed steel twist drill
 - 1 Accura slide rail with measuring scale in mm and inch, Length 500mm
 - 1 adjustable stop for front edge alignment
- ② Accura rail with metric and imperial measuring scale, with "System 32" marking points
- ┆ 500 mm
 - ┆ 1000 mm
 - ┆ 1500 mm
 - ┆ 2000 mm
- ③ Accura drill template for handles, including drilling plate with guide sleeve for 5 mm HSS twist drill bits aluminium/plastic
- ④ Replacement slide rail with drilling bushes for Accura drilling templates for handles
- ⑤ 5 mm twist drill bit
- ⑥ Adjustable stop for fronts and individual (dismantled) cabinet sides, plastic

- Gabarit de perçage Accura, kit pour poignées comprenant:
- 2 matrices de perçage Accura pour poignées
 - 2 plaques de perçage avec douille de guidage pour mèche à spirale à coupe rapide haute performance
 - 1 rail Accura avec graduation en mm et en pouces, Longueur 500mm
 - 1 butée réglable pour façades
- ② Rail Accura avec graduation en mm et en pouces, avec points de repérage système 32
- ┆ 500 mm
 - ┆ 1000 mm
 - ┆ 1500 mm
 - ┆ 2000 mm
- ③ Matrices de perçage Accura pour poignées, plaques de perçage avec douilles de guidage incl. pour mèche à spirale 5 mm aluminium/plastique
- ④ Coulisserie de rechange avec douille de perçage pour matrices de perçage Accura pour poignées
- ⑤ Mèche à spirale 5 mm
- ⑥ Butée réglable pour façades et côtés de caisson (démontés), plastique

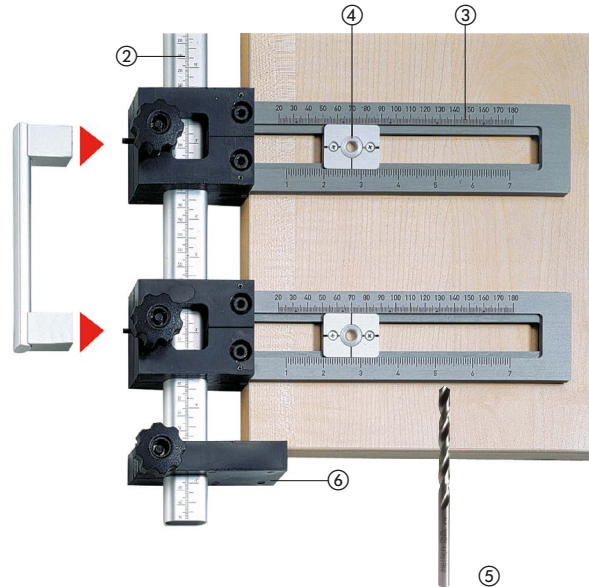

- Accura-boormal, set voor grepen bestaat uit:
- 2 Accura-boorlichamen voor grepen
 - 2 Verstelbare boorhulzen voor 5mm HSS-spiraalboor
 - 1 Accura-rail 500 mm met maatverdeling in mm en inch
 - 1 instelbare aanslag voor frontplaten
- ② Accura-rail met maatverdeling in mm en inch, met markeringspunten voor "Systeem 32"
- ┆ 500 mm
 - ┆ 1000 mm
 - ┆ 1500 mm
 - ┆ 2000 mm
- ③ Accura-boorlichaam voor grepen, boorplaat met boorhuls voor 5 mm HSS-spiraalboor aluminium/kunststof
- ④ Vervang- en verstelbare boorhulzen voor Accura-boorlichaam
- ⑤ Spiraalboor 5 mm
- ⑥ Instelbare aanslag voor fronten en aparte (gedemonteerde) kastzijwanden uit kunststof

	┆	□
2	500	0 044 763 1
2	1000	0 044 764 1
2	1500	0 070 263 1
2	2000	0 070 264 1
2		0 020 014 1
3		0 044 765 1
4		0 044 767 1
5		0 044 766 1
6		0 070 266 1

SERVICE

Accura-Bohrkörper für Griffe
Accura drilling jigs for handles
La plaque Accura pour poignées
Accura-boorlichaam voor grepen

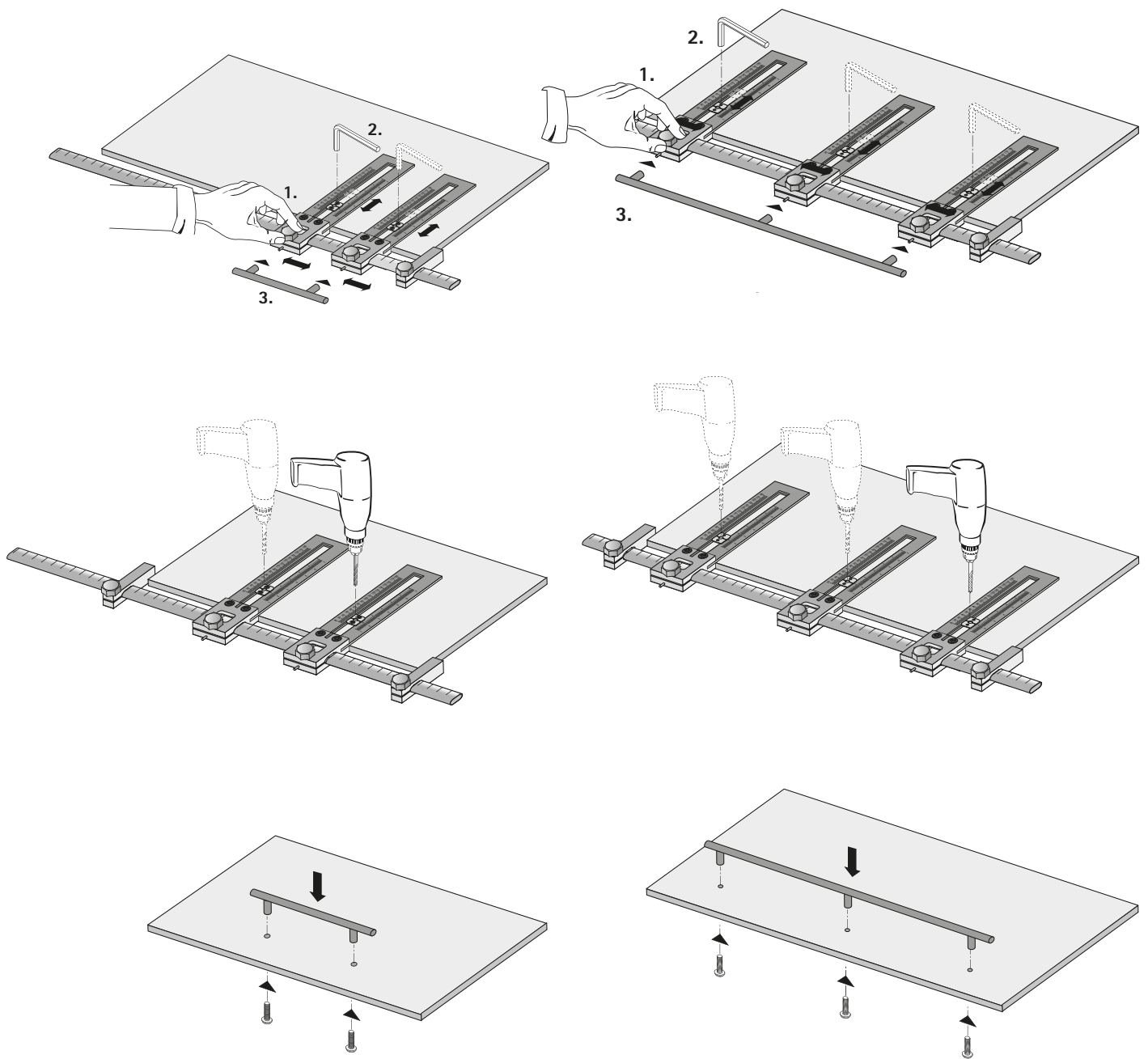

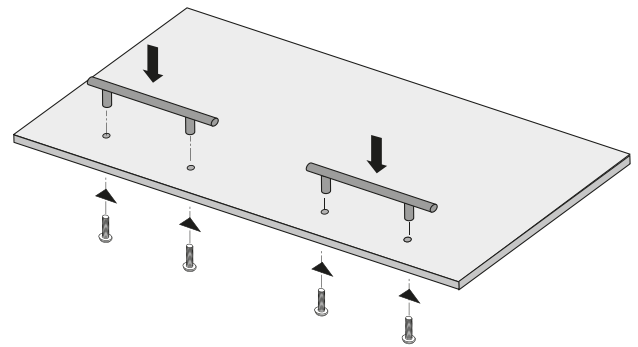
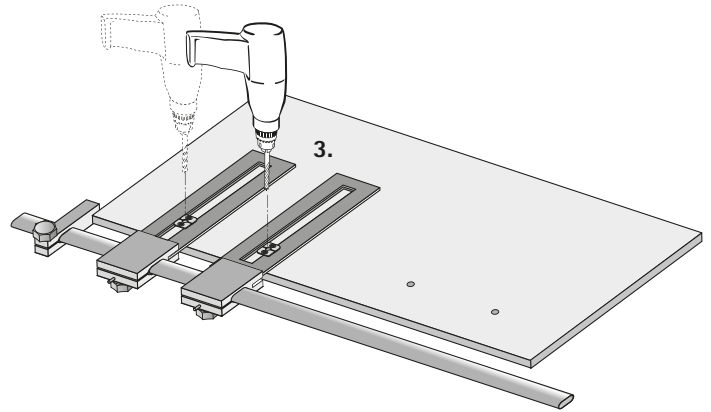
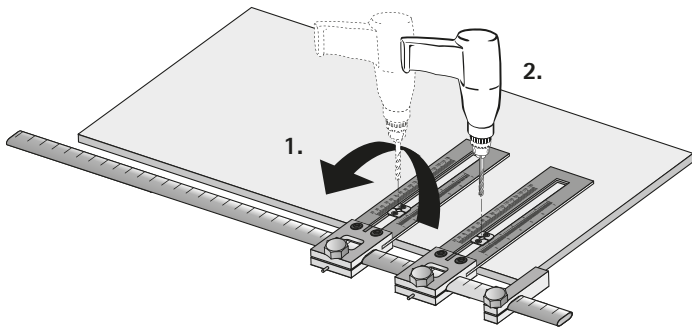

- Gewünschte Positionierung auf der Front einstellen
- Bohrabstand einstellen und über Abgreifelemente prüfen
- Bei einem Griff mit 2 oder 3 Sockeln: Eingestellte Bohrlehre auflegen und bohren
- Griff anschrauben

- Set chosen positioning on the front
- Set hole spacing and check using Handle fixing points
- For a handle with 2 or 3 stems: Place drilling jig on front and drill
- Screw on handle

- Régler la position souhaitée sur la façade
- Régler la distance de perçage et vérifier à l'aide des éléments ajustables
- Dans le cas d'une poignée centrée avec 2 ou 3 socles sur une façade: poser le gabarit de perçage réglé et percer
- Visser la poignée

- Gewenste positionering op op het front instellen
- Boorafstand instellen en m.b.t. meetelementen controleren
- Bij een greep met 2 of 3 sokkels: ingestelde boormal opleggen en boren
- Greep aanschroeven

Bei zwei symmetrisch positionierten Griffen: Bohrlehre zunächst an einer Seite anlegen um für den 1. Griff zu bohren, danach ohne Umstellung der Bohrlehre an der anderen Seite anlegen um für den 2. Griff zu bohren.

For two symmetrically positioned handles: First position drilling jig on one side to drill the holes for the 1st handle and then, without altering the setting, position drilling jig on the other side to drill the holes for the 2nd handle.

Dans le cas de 2 poignées placées symétriquement sur une façade: poser d'abord le gabarit de perçage d'un côté pour percer la 1^{ère} poignée, puis sans changer de gabarit de perçage, poser sur l'autre côté pour percer la 2^{ème} poignée.

Bij twee symmetrisch gepositioneerde grepen: De Accura boormal eerst aan één kant aanleggen, voor de 1ste greep te boren, dan zonder om te stellen de Accura boormal aan de andere kant aanleggen om de 2de greep te boren.

SERVICE

Universal-Ankörnlehre für Griffe und Knöpfe Universal hole marking template for handles and knobs Gabarit de centrage pour poignées et boutons Universele centreermal voor grepen en knoppen

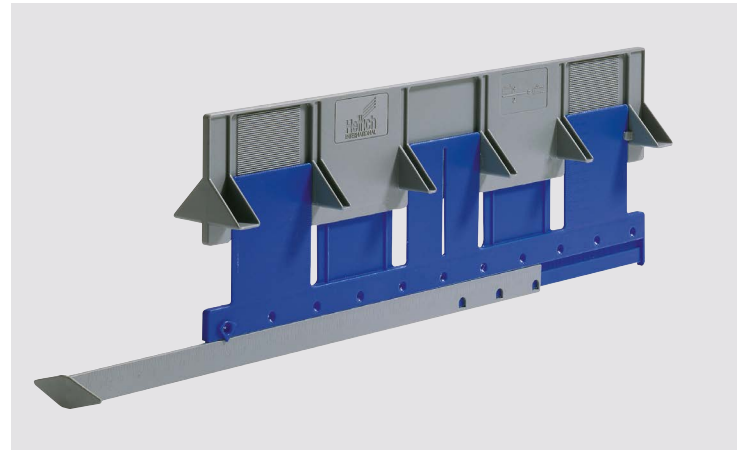

Zweidimensional einstellbare Ankörnlehre zur schnellen und präzisen Markierung der Bohrpositionen im System 32 für

- Griffe (Bohrabstand von 32-320 mm)
- Knöpfe

Einstellbereiche:

- Abstand Blendenseitenkante bis zur ersten Befestigungsbohrung des Griffes 10-334 mm
- Abstand Blendener-/Blendenunterkante bis zur Griffposition 20-65 mm

Adjustable, two-dimensional hole marking template for fast, accurate marking of System 32 hole patterns for

- Handles (Hole spacing of 32-320 mm)
- Knobs

Range of adjustment:

- Distance from drawer front side edge to first fixing hole of handle 10 - 334 mm
- Distance from drawer front top/bottom edge to position of handle 20 - 65 mm

Gabarit de centrage réglable sur 2 dimensions pour un marquage rapide et précis des positions de perçage en système 32 pour

- Poignées (distance de perçage de 32-320 mm)
- Boutons

Plage de réglage :

- Distance du chant latéral de bandeau au perçage de fixation de la poignée 10-334 mm
- Distance chant supérieur/inférieur de bandeau à la position de poignée 20-65 mm

Tweedimensioneel afstelbare centreermal voor de snelle en precieze markering van de boorposities in het Systeem 32 voor

- Grepen (boorafstand van 32-320 mm)
- Knoppen

Afstelbereiken:

- Afstand zijkant van de frontplaat tot de eerste bevestigingsbooring van de greep 10-334 mm
- Afstand boven-/onderkant van de frontplaat tot de greeppositie 20-65 mm

0 048 771 1 

Einstellung Höhen-Positionierung
 Setting for height positioning
 Réglage positionnement en hauteur
 Instelling hoogtepositionering

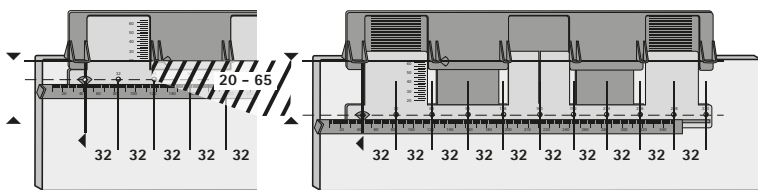

Berechnungsformeln
Calculations formulae
Formules de calcul
Berekeningsformules

Seiten-Positionierung für einen Griff
 Side positioning for a handle
 Positionnement latéral pour une poignée
 Zijdellingse positionering voor een greep

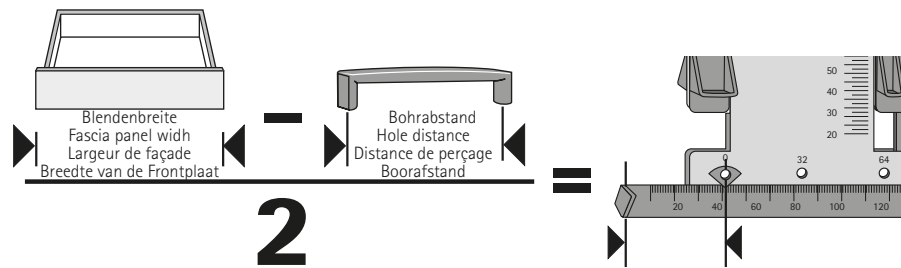

Abstand Blendenseitenkante bis zur ersten Befestigungsbohrung des Griffes (min. 10 mm / max. 334 mm)
 Distance from drawer front side edge to first fixing hole of handle (min. 10 mm / max. 334 mm)

Distance du chant latéral de bandeau au perçage de fixation de la poignée (min. 10 mm / max. 334 mm)
 Afstand zijkant van het front tot de eerste bevestigingsboring van de greep (min. 10 mm / max. 334 mm)

Seiten-Positionierung für einen Knopf
 Side positioning for a knob
 Positionnement latéral pour un bouton
 Zijdellingse positionering voor een knop

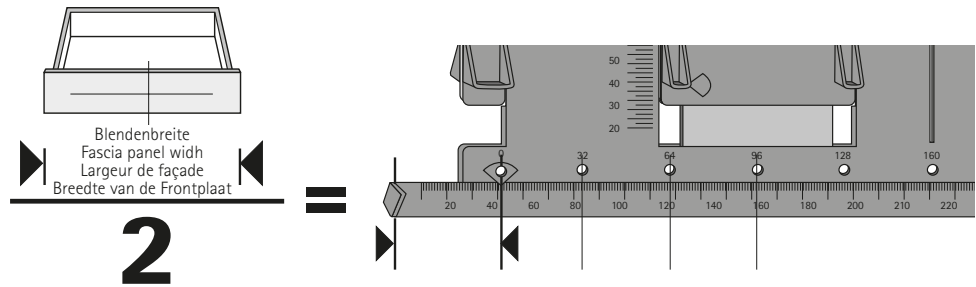

Abstand Blendenseitenkante bis zur Befestigungsbohrung des Knopfes (min. 10 mm / max. 334 mm)
 Distance from drawer front side edge to knob fixing hole (min. 10 mm / max. 334 mm)

Distance du chant latéral de bandeau au perçage de fixation du bouton (min. 10 mm / max. 334 mm)
 Afstand zijkant van het front tot de bevestigingsboring van de knop (min. 10 mm / max. 334 mm)

Einstellung Seiten-Positionierung
 Setting for side positioning
 Réglage positionnement latéral
 Instelling zijdelingse positionering

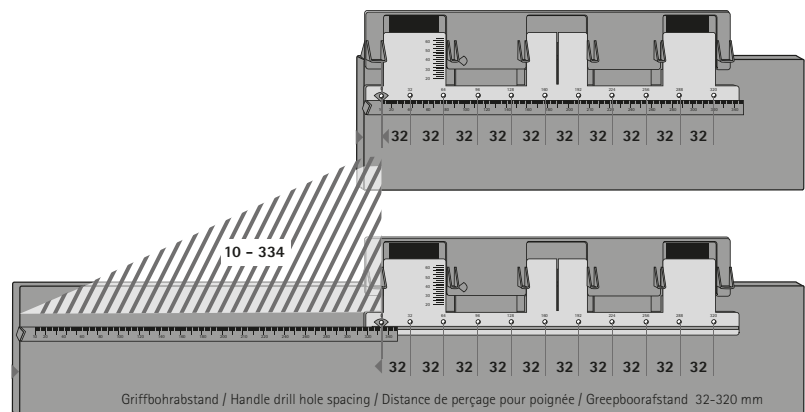

Griffbohrabstand / Handle drill hole spacing / Distance de perçage pour poignée / Grieffboorabstand 32-320 mm

SERVICE

Universal-Ankörnlehre für Griffe und Knöpfe Universal hole marking template for handles and knobs Gabarit de centrage pour poignées et boutons Universele centreermal voor grepen en knoppen

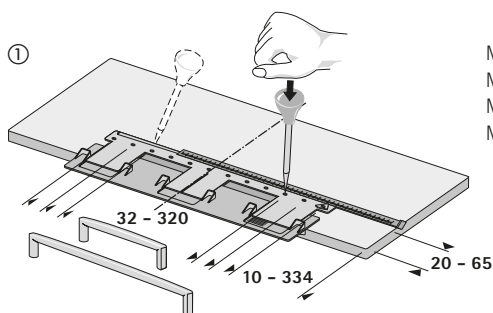

Montage – ein Griff
 Mounting – one handle
 Montage – une poignée
 Montage – één greep

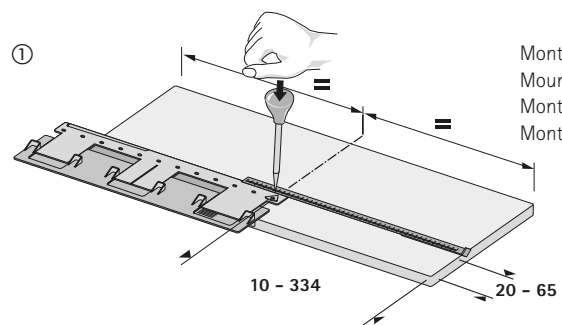

Montage – ein Knopf
 Mounting – one knob
 Montage – un bouton
 Montage – één knop

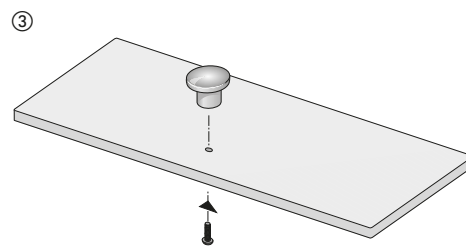
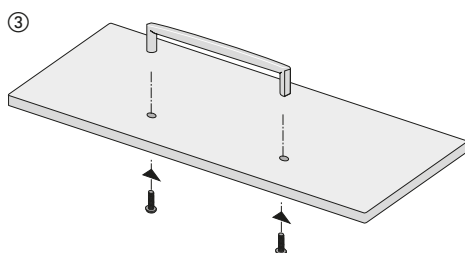
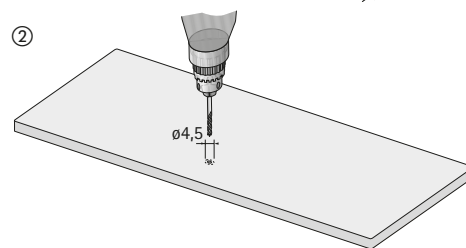
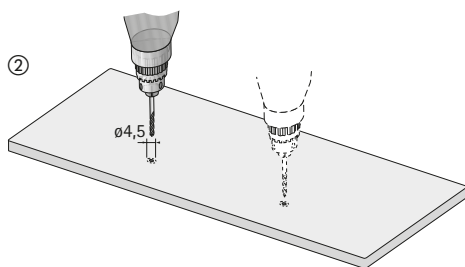

- ① Bohrlehre einstellen und Bohrpositionen ankörnen
- ① Set drilling jig and mark drill hole positions
- ① Régler le gabarit de perçage et centrer les positions de perçage
- ① Boormal afstellen en boorposities centreren

- ② Befestigungslöcher bohren
- ② Drill fixing holes
- ② Percer les trous de fixation
- ② Bevestigingsgaten boren

- ③ Griff anschrauben
- ③ Screw on handle
- ③ Visser la poignée
- ③ Greep aanschroeven

Für die exakte Übertragung der Bohrpositionen von rechts nach links kann die Universal-Ankörnlehre einfach umgekehrt angelegt werden.
 The universal hole marking template can simply be used the other way round for accurately transferring hole patterns from right to left.

- ① Bohrlehre einstellen und Bohrpositionen ankörnen
- ① Set drilling jig and mark drill hole positions
- ① Régler le gabarit de perçage et centrer les positions de perçage
- ① Boormal afstellen en boorposities centreren

- ② Befestigungslöcher bohren
- ② Drill fixing holes
- ② Percer les trous de fixation
- ② Bevestigingsgaten boren

- ③ Knopf anschrauben
- ③ Screw on knob
- ③ Visser le bouton
- ③ Knop aanschroeven

Pour le report exact des positions de perçage de la droite vers la gauche, il est possible de poser simplement le gabarit de centrage universel sur l'autre face.
 Voor de precieze overbrenging van de boorposities van rechts naar links kan de universele centreermal gewoonweg omgekeerd worden aangelegd.

Montage – zwei Griffe (symmetrisch positioniert)
 Mounting – two handles (positioned symmetrically)
 Montage – deux poignées (positionnement symétrique)
 Montage – twee grepen (symmetrisch gepositioneerd)

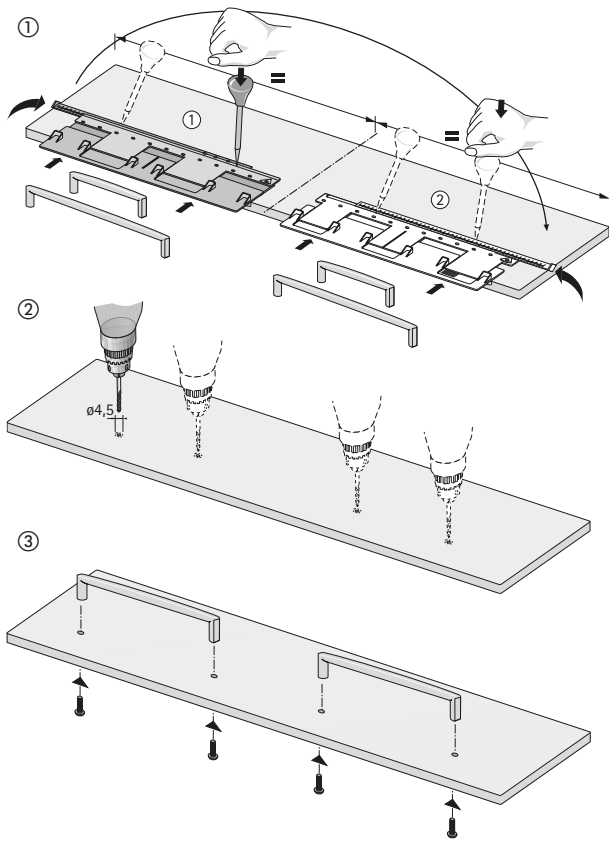

- ① Bohrlehre einstellen und Bohrpositionen ankönnen
- ① Set drilling jig and mark drill hole positions
- ① Régler le gabarit de perçage et centrer les positions de perçage
- ① Boormal afstellen en boorposities centreren

- ② Befestigungslöcher bohren
- ② Drill fixing holes
- ② Percer les trous de fixation
- ② Bevestigingsgaten boren

- ③ Griff anschrauben
- ③ Screw on handle
- ③ Visser la poignée
- ③ Greep aanschroeven

Für die exakte Übertragung der Bohrpositionen von rechts nach links kann die Universal-Ankörnlehre einfach umgekehrt angelegt werden.
 The universal hole marking template can simply be used the other way round for accurately transferring hole patterns from right to left.

Montage – zwei Knöpfe (symmetrisch positioniert)
 Mounting – two knobs (positioned symmetrically)
 Montage – deux boutons (positionnement symétrique)
 Montage – twee knoppen (symmetrisch gepositioneerd)

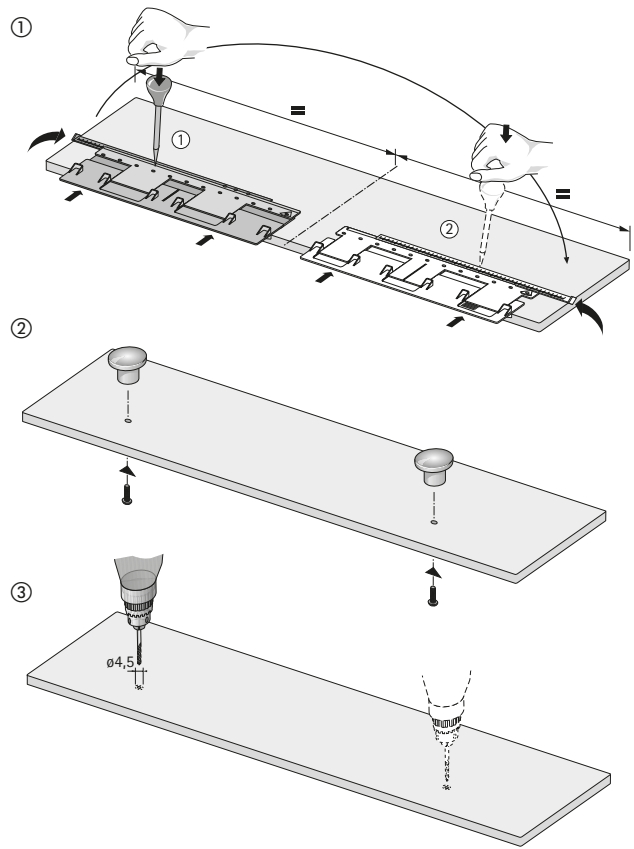

- ① Bohrlehre einstellen und Bohrpositionen ankönnen
- ① Set drilling jig and mark drill hole positions
- ① Régler le gabarit de perçage et centrer les positions de perçage
- ① Boormal afstellen en boorposities centreren

- ② Befestigungslöcher bohren
- ② Drill fixing holes
- ② Percer les trous de fixation
- ② Bevestigingsgaten boren

- ③ Knopf anschrauben
- ③ Screw on knob
- ③ Visser le bouton
- ③ Knop aanschroeven

Pour le report exact des positions de perçage de la droite vers la gauche, il est possible de poser simplement le gabarit de centrage universel sur l'autre face.
 Voor de precieze overbrenging van de boorposities van rechts naar links kan de universele centreermal gewoonweg omgekeerd worden aangelegd.

INDEX

Programmübersicht sortiert nach Materialien
 Product-line overview arranged by materials
 Aperçu du programme trié par matériaux
 Programma overzicht gesorteerd naar materiaal

Stahl
 Steel
 Acier
 Staal



17 Hale



63 Nicia



70 Avenio



90 Valentia

Stahl und Zink
 Steel and Zinc
 Acier et Zinc
 Staal en zink



37 Misnia



90 Malaca

Zink
 Zinc
 Zinc
 Zink



6 Vigilia



9 Evisa



10 Zenga



11 Nursia



12 Cheam



12 Tornea



16 Alvito

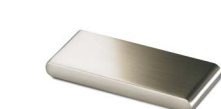

19 Fermo



26 Celistra



26 Genoa



27 Rialto



27 Messina



28 Milo



28 Venusia



35 Genzone



38 Novae



42 Amisia



42 Limpio



43 Istrana



43 Itri



44 Forli



45 Utinum



46 Buena



47 Baldone



47 Belluno



49 Intra



50 Veronia



50 Basilia



51 Arimini



51 Opera



51 Saturnia



52 Delia



52 Lodi



52 Sava



53 Solda

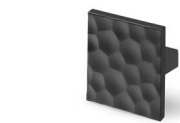

53 Londa



54 Fogo



54 Bona



58 Neapolis



58 Tolfo



58 Athena



59 Olivia



60 Felina



61 Coria



61 Parma



62 Balmo



62 Carvo



64 Bathia



64 Matilo



65 Salona



65 Ovada



66 Fectio



66 Vantania



67 Tolosa



67 Dinia



71 Belna



72 Lucca



73 Chalcis



73 Vieste



74 Suasa



74 Carolina



75 Trento



75 Meana



77 Tardiano



77 Ladera



77 Issa



78 Sala



78 Almus



79 Cirpi



79 Murcia



82 Cato



82 Calili



83 Ponzone



83 Ponti



84 Corduba



84 Vesontio



84 Ponoka



84 Oka



85 Luro



85 Tarraco

INDEX

Programmübersicht sortiert nach Materialien
 Product-line overview arranged by materials
 Aperçu du programme trié par matériaux
 Programma overzicht gesorteerd naar materiaal



85 Pomezia



85 Potovio



86 Barcino



86 Bracara



86 Olisipo



87 Arezzo

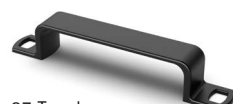

87 Topeka



88 Siradia



88 Sertao



89 Haida



89 Terranda



89 Gissi



89 Osimo



91 Egara



91 Bruxella



92 Salacia



92 Eburaco



92 Savelli



92 Salemi



93 Alberta



94 Meduno



94 Flavia



94 Emo



95 Bevipo



95 Dipo



100 Lorica



100 Matane



101 Essa



101 Tonala



102 Galleno



102 Fossa



102 Solva



103 Altedo



103 Larru

Aluminium
 Aluminium
 Aluminium
 Aluminium



7 Apua



7 Nubia



8 Torino



8 Velitra



9 Capua



9 Imperia



15 Clivia



19 Kervo



20 Stabia



21 Rovigo



22/23 Canis L



24/25 Canis C



29 Trani



29 Ticinum



31 Lamezia



32 Lindavia



32 Lutetia



32 Eslinga



32 Seveso



33 Mosena

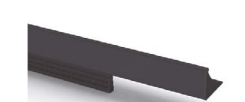

34 Riaza



68 Naila



68 Culmen



72 Catana



76 Codania



93 Ogulin

Aluminium und Zink
Aluminium and Zinc
Aluminium et Zinc
Aluminium en zink



11 Bermeo



35 Capris



36 Nidum



36 Spira



59 Borgo

Edelstahl
Stainless steel
Acier inoxydable
Roestvrij staal



6 Tempe



13 Anzio



13 Arnum



14 Aratti



14 Aosta



16 Pola



16 Guarani



16 Narona



18 Salvia



30 Narni



37 Apolda



38 Onex



38 Agrinum



38 Monacum



39 Danum



39 Sion



39 Spalatum

INDEX

Programmübersicht sortiert nach Materialien
Product-line overview arranged by materials
Aperçu du programme trié par matériaux
Programma overzicht gesorteerd naar materiaal



48 Ponte



60 Aboa



69 Vada



71 Asopus



77 Sipontum



79 Serbinum



100 Dodona

Messing
Brass
Laiton
Messing



30 Empoli

Edelstahl und Zink
Stainless steel and Zinc
Acier inoxydable et Zinc
Roestvrij staal en zink



44 Brema



45 Como

Stahl und Edelstahl
Steel and Stainless steel
Acier et Acier inoxydable
Staal en roestvrij staal



48 Cecina

Zink und Kunststoff
Zinc and plastic
Zinc et Plastique
Zink en kunststof



105 Touch-in



105 Touch-in

Leder
Leather
Cuir
Leer



97 Gela



97 Galati



98 Nica

Leder und Stahl
Leather and Steel
Cuir et Acier
Leer en staal



96 Byzantia

Leder und Messing
Leather and Brass
Cuir et Laiton
Leer en messing



98 Filaga

Leder und Zink
Leather and Zinc
Cuir et Zinc
Leer en zink



99 Agna



99 Agliano



99 Dublina

Leder und Edelstahl
Leather and Stainless steel
Cuir et Acier inoxydable
Leer en roestvrij staal



96 Getafe

Leder, Holz und Zink
Leather, Wood and Zinc
Cuir, Bois et Zinc
Leer, hout en zink



99 Arago

Sachwortverzeichnis
Product Index
Index
Trefwoordregister

Aboa	60	Como	45	Matane	100	Solda	53
Agliano	99	Corduba	84	Matilo	64	Solva	102
Agna	99	Coria	61	Meana	75	Spalatum	39
Agrinum	38	Culmen	68	Meduno	94	Spira	36
Alberta	93	Danum	39	Messana	27	Stabia	20
Almus	78	Delia	52	Milo	28	Suasa	74
Altedo	103	Dinia	67	Misnia	37	Tardiano	77
Alvito	16	Dipo	95	Monacum	38	Tarraco	85
Amisia	42	Dodona	100	Mosena	33	Tempe	6
Anzio	13	Dublina	99	Murcia	79	Terranda	89
Aosta	14	Eburaco	92	Naila	68	Ticinum	29
Apolda	37	Egara	91	Narni	30	Tolfo	58
Apua	7	Emo	94	Narona	16	Tolosa	67
Arago	99	Empoli	30	Neapolis	58	Tonala	101
Aratti	14	Eslinga	32	Nica	98	Topeka	87
Arezzo	87	Essa	101	Nicia	63	Torino	8
Arimini	51	Evisa	9	Nidum	36	Tornea	12
Arnum	13	Fectio	66	Novae	38	Touch-in	105
Asopus	71	Felina	60	Nubia	7	Trani	29
Athens	58	Fermo	19	Nursia	11	Trento	75
Avenio	70	Filaga	98	Ogulin	93	Utinum	45
Baldone	47	Flavia	94	Oka	84	Vada	69
Balmo	62	Fogo	54	Olisipo	86	Valentia	90
Barcino	86	Forli	44	Olivia	59	Vantania	66
Basilia	50	Fossa	102	Onex	38	Velitra	8
Bathia	64	Galati	97	Opera	51	Venusia	28
Belluno	47	Galleno	102	Osimo	89	Veronia	50
Belna	71	Gela	97	Ovada	65	Vesontio	84
Bermeo	11	Genoa	26	Parma	61	Vieste	73
Bevipo	95	Genzone	35	Pola	16	Vigilia	6
Bona	54	Getafe	96	Pomezia	85	Zenga	10
Borgoa	59	Gissi	89	Ponoka	84		
Bracara	86	Guarani	16	Ponte	48		
Brema	44	Haida	89	Ponti	83		
Bruxella	91	Hale	17	Ponzone	83		
Buena	46	Imperia	9	Potovio	85		
Byzantia	96	Intra	49	Rialto	27		
Calili	82	Issa	77	Riaza	34		
Canis C	24/25	Istrana	43	Rovigo	21		
Canis L	22/23	Itri	43	Sala	78		
Capris	35	Kervo	19	Salacia	92		
Capua	9	Ladera	77	Salemi	92		
Carolina	74	Lamezia	31	Salona	65		
Carvo	62	Larru	103	Salvia	18		
Catana	72	Limpio	42	Saturnia	51		
Cato	82	Lindavia	32	Sava	52		
Cecina	48	Lodi	52	Savelli	92		
Celista	26	Londa	53	Serbinum	79		
Chalcis	73	Lorica	100	Sertao	88		
Cheam	12	Lucca	72	Seveso	32		
Cirpi	79	Luro	85	Sion	39		
Clivia	15	Lutetia	32	Sipontum	77		
Codania	76	Malaca	90	Siradia	88		

INDEX

Bestellnummernverzeichnis

Order Number Index

Index des références de commande

Overzicht bestelnummers

0 020 014	115	0 115 081	72	0 115 360	15	9 069 909	70	9 070 448	70
0 043 472	62	0 115 090	32	0 115 361	15	9 069 915	70	9 070 451	69
0 043 502	47	0 115 091	32	0 115 362	15	9 069 919	70	9 070 457	69
0 043 503	47	0 115 115	32	0 115 363	15	9 069 922	70	9 070 466	69
0 043 505	47	0 115 122	58	0 115 364	15	9 069 927	70	9 070 481	69
0 043 506	47	0 115 127	37	0 115 365	113	9 069 942	71	9 070 492	64
0 043 642	47	0 115 146	68	0 115 366	113	9 069 943	70	9 070 493	64
0 043 643	47	0 115 147	68	0 115 374	86	9 070 025	70	9 070 494	69
0 044 763	115	0 115 148	68	0 115 385	48	9 070 030	70	9 070 501	69
0 044 764	115	0 115 149	68	0 115 387	48	9 070 054	70	9 070 504	69
0 044 765	115	0 115 150	68	1 160 018	13	9 070 075	70	9 070 508	64
0 044 766	115	0 115 152	68	1 160 019	13	9 070 078	70	9 070 509	69
0 044 767	115	0 115 153	68	1 160 020	13	9 070 095	75	9 070 510	90
0 046 700	112	0 115 154	28	1 160 021	13	9 070 096	71	9 070 511	70
0 048 771	118	0 115 155	28	1 160 022	13	9 070 101	71	9 070 512	70
0 070 263	115	0 115 156	27	1 160 023	13	9 070 102	71	9 070 513	90
0 070 264	115	0 115 157	27	1 160 024	13	9 070 103	71	9 070 516	64
0 070 266	115	0 115 169	71	1 160 025	13	9 070 104	44	9 070 519	70
0 071 544	112	0 115 170	71	1 170 155	65	9 070 105	71	9 070 520	54
0 071 545	112	0 115 181	37	1 170 158	66	9 070 106	44	9 070 521	70
0 071 546	112	0 115 182	37	1 170 173	94	9 070 107	44	9 070 522	70
0 071 547	112	0 115 183	37	9 064 670	9	9 070 108	44	9 070 523	54
0 071 548	112	0 115 195	64	9 064 671	9	9 070 109	44	9 070 527	70
0 071 549	112	0 115 203	67	9 064 819	7	9 070 110	44	9 070 540	70
0 071 555	112	0 115 205	15	9 064 820	7	9 070 111	71	9 070 548	70
0 071 556	112	0 115 206	15	9 065 425	58	9 070 112	44	9 070 552	70
0 071 557	112	0 115 207	15	9 065 426	58	9 070 113	44	9 070 556	59
0 071 558	112	0 115 208	15	9 065 427	58	9 070 117	71	9 070 557	70
0 071 559	112	0 115 209	15	9 065 611	26	9 070 118	71	9 070 562	79
0 071 560	112	0 115 210	15	9 065 612	26	9 070 119	71	9 070 565	59
0 071 561	112	0 115 211	15	9 065 627	6	9 070 120	71	9 070 567	59
0 071 562	112	0 115 212	15	9 065 628	6	9 070 121	75	9 070 568	77
0 071 563	112	0 115 213	15	9 065 634	50	9 070 122	71	9 070 572	70
0 071 855	112	0 115 214	15	9 065 635	50	9 070 123	75	9 070 574	59
0 071 856	112	0 115 215	15	9 069 804	14	9 070 124	71	9 070 575	102
0 074 134	62	0 115 216	15	9 069 805	14	9 070 125	75	9 070 577	70
0 115 014	8	0 115 217	15	9 069 806	14	9 070 138	60	9 070 580	39
0 115 016	8	0 115 218	15	9 069 807	14	9 070 142	96	9 070 581	79
0 115 017	8	0 115 263	95	9 069 808	14	9 070 143	96	9 070 583	29
0 115 018	8	0 115 264	95	9 069 815	71	9 070 144	96	9 070 585	79
0 115 019	19	0 115 266	84	9 069 818	71	9 070 147	96	9 070 586	79
0 115 020	19	0 115 292	94	9 069 821	71	9 070 148	96	9 070 588	29
0 115 021	20	0 115 293	94	9 069 865	71	9 070 149	96	9 070 589	79
0 115 022	20	0 115 298	36	9 069 867	70	9 070 263	38	9 070 593	29
0 115 023	20	0 115 312	77	9 069 868	70	9 070 264	38	9 070 602	70
0 115 024	20	0 115 314	36	9 069 873	70	9 070 420	71	9 070 605	70
0 115 028	35	0 115 353	15	9 069 877	70	9 070 421	71	9 070 619	70
0 115 049	35	0 115 354	15	9 069 890	44	9 070 429	70	9 070 624	61
0 115 060	48	0 115 355	15	9 069 892	70	9 070 439	70	9 070 625	70
0 115 076	50	0 115 356	15	9 069 893	44	9 070 440	69	9 070 674	17
0 115 077	45	0 115 357	15	9 069 899	70	9 070 443	70	9 070 675	67
0 115 078	45	0 115 358	15	9 069 900	70	9 070 444	70	9 070 681	67
0 115 080	72	0 115 359	15	9 069 907	70	9 070 446	69	9 070 693	100

9 070 722	63	9 070 985	63	9 071 068	63	9 086 701	107	9 106 169	7
9 070 723	63	9 070 986	63	9 071 071	36	9 086 702	107	9 109 703	45
9 070 732	17	9 070 988	18	9 071 073	36	9 097 899	58	9 112 583	78
9 070 733	17	9 070 991	18	9 071 075	36	9 097 900	58	9 112 588	78
9 070 734	17	9 070 992	16	9 071 079	36	9 097 946	50	9 112 590	78
9 070 735	39	9 070 993	18	9 071 082	36	9 097 947	50	9 112 591	92
9 070 736	17	9 070 995	16	9 071 109	78	9 097 950	27	9 112 594	92
9 070 738	17	9 070 996	18	9 071 110	78	9 097 953	27	9 112 595	61
9 070 740	39	9 070 997	63	9 071 111	18	9 105 735	49	9 112 596	61
9 070 742	17	9 070 998	16	9 071 112	18	9 105 737	49	9 112 597	61
9 070 743	17	9 070 999	18	9 071 115	18	9 105 742	10	9 112 599	102
9 070 744	39	9 071 000	16	9 071 116	18	9 105 743	10	9 112 600	86
9 070 746	17	9 071 001	63	9 071 118	18	9 105 746	10	9 112 601	85
9 070 747	17	9 071 003	18	9 071 120	18	9 105 747	10	9 112 607	85
9 070 750	17	9 071 005	18	9 071 718	91	9 105 793	28	9 112 613	66
9 070 751	17	9 071 008	18	9 071 719	91	9 105 794	28	9 112 615	66
9 070 752	67	9 071 009	18	9 071 720	91	9 105 801	31	9 112 619	91
9 070 753	17	9 071 010	16	9 071 836	98	9 105 802	31	9 112 623	62
9 070 754	67	9 071 012	18	9 071 837	98	9 105 803	31	9 112 631	86
9 070 755	17	9 071 013	16	9 071 838	98	9 105 805	31	9 112 632	86
9 070 756	17	9 071 014	63	9 071 839	98	9 105 806	31	9 112 633	38
9 070 758	17	9 071 016	63	9 071 840	98	9 105 807	31	9 112 634	38
9 070 759	17	9 071 017	18	9 071 841	98	9 105 809	31	9 112 635	84
9 070 763	17	9 071 018	63	9 071 842	98	9 105 810	31	9 112 637	11
9 070 765	17	9 071 019	63	9 071 843	98	9 105 811	31	9 112 644	77
9 070 784	63	9 071 020	18	9 071 844	98	9 105 813	31	9 112 646	102
9 070 796	17	9 071 021	18	9 071 869	16	9 105 815	31	9 112 650	85
9 070 803	17	9 071 023	18	9 071 926	8	9 105 816	31	9 112 651	89
9 070 807	17	9 071 024	18	9 071 927	8	9 105 819	31	9 112 652	86
9 070 809	17	9 071 026	18	9 071 929	8	9 105 820	31	9 112 653	92
9 070 811	17	9 071 027	18	9 071 930	8	9 105 821	31	9 112 654	92
9 070 813	17	9 071 030	18	9 077 861	113	9 105 822	31	9 112 655	100
9 070 816	17	9 071 037	63	9 080 838	26	9 105 823	31	9 112 660	44
9 070 817	17	9 071 038	18	9 080 850	84	9 105 824	31	9 112 662	94
9 070 821	17	9 071 039	63	9 080 851	84	9 105 825	31	9 112 664	51
9 070 825	17	9 071 041	19	9 080 852	84	9 105 826	31	9 112 666	9
9 070 943	90	9 071 042	18	9 080 853	84	9 105 827	31	9 112 667	9
9 070 945	90	9 071 043	18	9 080 858	74	9 105 828	31	9 112 672	7
9 070 957	38	9 071 045	18	9 080 859	74	9 105 829	31	9 112 674	7
9 070 958	38	9 071 046	18	9 082 136	26	9 105 830	31	9 112 909	67
9 070 967	18	9 071 048	18	9 082 137	26	9 105 831	31	9 112 910	67
9 070 970	16	9 071 049	63	9 086 687	105	9 105 832	31	9 112 914	64
9 070 972	18	9 071 050	18	9 086 688	105	9 105 833	31	9 112 915	74
9 070 973	16	9 071 051	18	9 086 689	105	9 105 834	31	9 112 916	74
9 070 975	16	9 071 052	18	9 086 690	105	9 105 835	31	9 112 938	12
9 070 976	63	9 071 053	18	9 086 691	106	9 105 836	31	9 112 940	12
9 070 977	16	9 071 054	18	9 086 692	106	9 105 837	7	9 112 941	12
9 070 978	18	9 071 055	18	9 086 693	106	9 105 838	7	9 112 943	12
9 070 979	16	9 071 056	18	9 086 694	106	9 105 839	7	9 113 179	93
9 070 980	63	9 071 058	18	9 086 695	107	9 105 840	7	9 113 180	93
9 070 982	18	9 071 060	36	9 086 696	107	9 106 166	7	9 113 181	93
9 070 983	63	9 071 063	63	9 086 697	107	9 106 167	7	9 113 182	73
9 070 984	18	9 071 067	63	9 086 698	107	9 106 168	7	9 113 183	73

INDEX

Bestellnummernverzeichnis

Order Number Index

Index des références de commande

Overzicht bestelnummers

9 113 210	66	9 113 635	16	9 190 399	68	9 204 159	20	9 207 483	49
9 113 211	66	9 113 645	97	9 190 421	68	9 204 160	20	9 207 488	44
9 113 212	12	9 113 646	97	9 190 422	68	9 204 161	20	9 207 531	37
9 113 220	101	9 113 647	97	9 190 423	68	9 204 162	20	9 207 534	60
9 113 221	101	9 113 648	97	9 190 424	68	9 204 163	20	9 208 026	88
9 113 222	101	9 113 649	97	9 190 425	68	9 204 164	13	9 208 027	88
9 113 223	101	9 113 650	97	9 190 426	68	9 204 175	13	9 208 030	82
9 113 224	54	9 113 651	112	9 190 427	68	9 204 177	13	9 208 046	16
9 113 225	89	9 113 652	112	9 190 428	68	9 204 195	21	9 208 047	16
9 113 227	89	9 113 653	112	9 190 429	68	9 204 196	21	9 208 048	16
9 113 228	100	9 113 654	112	9 190 430	68	9 204 197	21	9 208 049	16
9 113 247	14	9 113 659	103	9 190 431	68	9 206 115	68	9 208 064	88
9 113 248	14	9 113 675	51	9 190 432	68	9 206 116	68	9 208 065	88
9 113 250	14	9 113 678	51	9 190 433	68	9 206 117	68	9 208 068	82
9 113 251	14	9 113 681	51	9 190 434	68	9 206 119	68	9 208 070	14
9 113 252	14	9 113 685	52	9 190 435	68	9 206 120	68	9 208 071	13
9 113 255	14	9 113 690	52	9 190 436	19	9 206 122	68	9 208 072	13
9 113 257	14	9 113 691	98	9 190 437	19	9 206 124	68	9 208 073	11
9 113 258	14	9 113 694	98	9 190 438	19	9 206 126	86	9 208 074	11
9 113 286	102	9 113 696	52	9 190 439	19	9 206 127	86	9 208 075	11
9 113 292	89	9 113 699	52	9 190 440	19	9 206 128	86	9 208 076	11
9 113 293	103	9 113 700	52	9 190 441	19	9 206 129	86	9 208 077	11
9 113 297	21	9 113 712	51	9 190 442	19	9 206 130	86	9 208 078	11
9 113 298	21	9 113 719	51	9 190 443	19	9 206 131	86	9 208 079	11
9 113 299	21	9 113 733	72	9 190 444	19	9 206 132	102	9 208 080	11
9 113 300	21	9 113 734	72	9 190 445	42	9 206 133	102	9 208 081	11
9 113 327	89	9 113 800	49	9 190 446	42	9 206 134	83	9 208 082	11
9 113 347	113	9 114 036	78	9 191 722	6	9 206 136	83	9 208 083	11
9 113 368	92	9 114 539	75	9 191 745	37	9 206 137	85	9 208 084	11
9 113 371	60	9 114 747	58	9 194 367	19	9 206 138	85	9 208 085	11
9 113 373	60	9 118 517	65	9 194 368	19	9 206 237	85	9 208 086	11
9 113 397	53	9 118 518	65	9 199 030	48	9 206 239	85	9 208 087	11
9 113 404	53	9 118 520	65	9 199 091	48	9 206 642	64	9 208 088	11
9 113 429	83	9 118 521	65	9 199 092	48	9 206 738	79	9 208 089	34
9 113 430	83	9 118 523	65	9 199 093	48	9 206 741	30	9 208 090	34
9 113 444	89	9 118 524	65	9 203 958	77	9 207 348	13	9 208 091	34
9 113 445	89	9 118 858	44	9 203 963	16	9 207 349	13	9 208 092	34
9 113 451	99	9 120 134	20	9 204 022	21	9 207 350	13	9 208 093	34
9 113 453	99	9 120 199	11	9 204 023	21	9 207 351	13	9 208 094	34
9 113 454	99	9 131 319	96	9 204 024	21	9 207 352	13	9 208 095	34
9 113 467	61	9 131 320	96	9 204 025	21	9 207 354	13	9 208 097	34
9 113 468	61	9 131 321	96	9 204 026	21	9 207 356	13	9 208 098	34
9 113 483	92	9 131 322	96	9 204 027	21	9 207 357	14	9 208 099	34
9 113 501	9	9 131 323	96	9 204 028	21	9 207 358	14	9 208 100	34
9 113 502	9	9 131 324	96	9 204 029	21	9 207 443	79	9 208 101	34
9 113 508	99	9 131 455	29	9 204 030	21	9 207 444	46	9 208 102	34
9 113 509	99	9 132 312	43	9 204 031	21	9 207 445	46	9 208 103	34
9 113 510	72	9 132 314	43	9 204 032	21	9 207 446	46	9 208 551	8
9 113 511	72	9 145 262	35	9 204 033	21	9 207 447	46	9 208 578	8
9 113 514	67	9 145 263	35	9 204 136	78	9 207 452	99	9 208 579	8
9 113 564	39	9 149 293	35	9 204 153	103	9 207 480	49	9 208 580	8
9 113 565	38	9 149 296	35	9 204 157	20	9 207 481	49	9 209 058	20
9 113 594	98	9 158 400	30	9 204 158	20	9 207 482	49	9 209 059	20

9 209 060	20	9 264 081	44	9 265 988	31	9 266 415	59	9 995 585	9
9 209 061	20	9 264 082	44	9 265 989	31	9 266 416	59	9 995 586	9
9 209 062	20	9 264 084	44	9 265 990	31	9 266 417	42	9 995 587	9
9 209 063	20	9 264 085	44	9 265 991	31	9 266 418	42	9 995 588	9
9 209 064	20	9 264 086	27	9 265 992	31	9 266 419	87	9 995 589	9
9 209 994	76	9 264 087	11	9 265 993	31	9 266 420	87	9 995 590	9
9 209 995	76	9 264 088	49	9 265 994	31	9 266 561	101	9 995 771	47
9 209 996	76	9 265 879	15	9 265 997	76	9 266 562	93	9 995 772	47
9 209 997	76	9 265 880	15	9 265 998	76	9 266 563	93	9 995 773	47
9 210 058	76	9 265 885	77	9 265 999	76	9 266 564	93	9 995 780	47
9 210 059	76	9 265 886	103	9 266 000	76	9 266 565	93	9 995 781	47
9 210 060	76	9 265 887	60	9 266 001	76	9 266 566	85	9 995 782	47
9 210 061	76	9 265 888	15	9 266 002	76	9 266 567	85		
9 210 062	76	9 265 921	15	9 266 003	76	9 266 568	85		
9 210 063	76	9 265 922	15	9 266 004	76	9 268 219	12		
9 210 115	22	9 265 923	15	9 266 005	76	9 268 262	12		
9 210 116	22	9 265 924	15	9 266 006	76	9 269 731	12		
9 210 117	22	9 265 925	15	9 266 067	76	9 269 732	12		
9 210 119	22	9 265 926	15	9 266 068	76	9 269 733	47		
9 210 122	23	9 265 927	15	9 266 069	76	9 269 734	47		
9 210 125	23	9 265 928	15	9 266 070	76	9 269 735	47		
9 210 126	23	9 265 929	15	9 266 071	76	9 269 736	47		
9 210 128	23	9 265 930	15	9 266 072	76	9 269 741	53		
9 210 129	23	9 265 931	15	9 266 073	76	9 269 742	53		
9 210 129	25	9 265 932	15	9 266 074	76	9 270 230	87		
9 210 130	24	9 265 933	15	9 266 075	76	9 270 437	47		
9 210 132	24	9 265 934	15	9 266 076	76	9 270 438	47		
9 210 133	24	9 265 935	15	9 266 077	68	9 270 439	47		
9 210 136	24	9 265 936	15	9 266 078	68	9 277 179	59		
9 210 138	25	9 265 937	15	9 266 079	68	9 995 122	32		
9 210 139	25	9 265 938	15	9 266 080	68	9 995 123	32		
9 210 140	25	9 265 939	15	9 266 091	68	9 995 437	29		
9 210 141	25	9 265 940	15	9 266 092	68	9 995 438	29		
9 210 142	23	9 265 941	15	9 266 093	68	9 995 439	29		
9 210 142	25	9 265 942	15	9 266 094	68	9 995 440	29		
9 210 143	23	9 265 943	15	9 266 095	34	9 995 480	47		
9 210 143	25	9 265 949	29	9 266 096	34	9 995 481	47		
9 212 860	112	9 265 950	29	9 266 097	34	9 995 482	47		
9 237 970	33	9 265 971	29	9 266 098	34	9 995 483	47		
9 252 428	12	9 265 972	29	9 266 099	34	9 995 484	47		
9 252 429	12	9 265 973	31	9 266 100	34	9 995 485	47		
9 252 430	12	9 265 975	31	9 266 101	34	9 995 497	73		
9 260 744	100	9 265 976	31	9 266 102	34	9 995 498	73		
9 264 060	87	9 265 977	31	9 266 104	22	9 995 499	73		
9 264 072	45	9 265 978	31	9 266 105	22	9 995 500	73		
9 264 073	45	9 265 979	31	9 266 106	23	9 995 501	73		
9 264 074	44	9 265 980	31	9 266 107	23	9 995 540	30		
9 264 075	44	9 265 981	31	9 266 132	24	9 995 541	30		
9 264 076	44	9 265 982	31	9 266 133	24	9 995 542	30		
9 264 077	44	9 265 983	31	9 266 134	25	9 995 546	47		
9 264 078	44	9 265 985	31	9 266 135	25	9 995 547	47		
9 264 079	44	9 265 986	31	9 266 141	77	9 995 548	47		
9 264 080	44	9 265 987	31	9 266 142	77	9 995 574	30		

Impressum:

© Hettich Marketing- und Vertriebs GmbH & Co. KG
Gerhard-Lüking-Str. 10
32602 Vlotho, Deutschland

Für diesen Katalog behalten wir uns alle Rechte aus dem Urheberrecht vor. Ohne unsere schriftliche Genehmigung ist es nicht gestattet, den Katalog oder Teile daraus in irgendeiner Form zu vervielfältigen.
Technische Änderungen vorbehalten.
Keine Gewährleistung für Druckfehler oder Irrtümer.
Farbabweichungen vorbehalten.

März 2020
Bestell-Nr.: 9 279 364

Publisher's imprint

© Hettich Marketing- und Vertriebs GmbH & Co. KG
Gerhard-Lüking-Str. 10
32602 Vlotho, Germany

We reserve all rights to this catalogue under copyright law. It shall not be permissible to duplicate this catalogue in any form either in whole or in part without our written consent.
Subject to technical alterations.
Errors and omissions excepted.
Subject to colour variations.

March 2020
Order no.: 9 279 364

Note de l'éditeur

© Hettich Marketing- und Vertriebs GmbH & Co. KG
Gerhard-Lüking-Str. 10
32602 Vlotho, Allemagne

Tous droits d'auteurs nous sont réservés pour ce catalogue. Toute reproduction ou représentation, intégrale ou partielle, faite sans notre autorisation écrite est illicite. Sous réserve de modifications techniques. Nous déclinons toute responsabilité pour d'éventuelles erreurs ou fautes d'impression. Sous réserve de différences de couleur.

Mars 2020
Référence : 9 279 364

Impressum:

© Hettich Marketing- und Vertriebs GmbH & Co. KG
Gerhard-Lüking-Str. 10
32602 Vlotho, Duitsland

Voor deze catalogus behouden wij ons alle auteursrechten voor. Zonder onze schriftelijke toestemming is het verboden deze catalogus of delen daarvan in welke vorm dan ook te vermenigvuldigen.
Technische wijzigingen vorbehalten.
Wij zijn niet aansprakelijk voor drukfouten of andere vergissingen.
Kleurafwijkingen vorbehalten.

Maart 2020
Bestelnr.: 9 279 364

Lernen Sie das Familien-
unternehmen Hettich
näher kennen!

Learn more about the
Hettich family-owned company
and get to know us better!

Apprenez-en plus sur l'entreprise
familiale Hettich !

Leer het familiebedrijf
Hettich beter kennen!

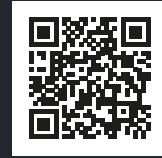

Bestell-Nr.: 9 279 364
1908-044_ProDeco_Basiskg_03/20_HMM/de/en/fr/nl

Technik für Möbel

Hettich